

MAGNUM DIMENSIONS



PT-100 MPPT Charge Controller

Owner's Manual



Thank you from all of us at Sensata Technologies for purchasing this PT-100 MPPT charge controller. The PT-100 is a product under the Magnum-Dimensions brand from Sensata Technologies. We understand that you have many purchasing options in the marketplace, and we are pleased that you have decided on this product. This PT-100 was proudly assembled and tested in the United States at our facility in Everett, Washington.

At Sensata, we are committed to providing you with quality products and services, and hope that your experience with us is pleasant and professional.

Disclaimer of Liability

This manual provides detailed installation and operation information for the PT-100 charge controller and is intended for the system installer and operator. The use of this manual and the conditions or methods of installation, operation, use and maintenance of the PT-100 controller are beyond the control of Sensata Technologies. Therefore, this company does not assume responsibility and expressly disclaims liability for loss, damage, or expense whether direct, indirect, consequential or incidental that may arise out of or be any way connected with such installation, operation, use, or maintenance.

Due to continuous improvements and product updates, the images shown in this manual may not exactly match the unit purchased.

Restrictions on Use

The PT-100 may only be used in life support devices and systems with the express written approval of Sensata Technologies. Failure of this charge controller can reasonably be expected to cause failure of that life support device or system, or to affect the safety or effectiveness of that device or system. If the PT-100 fails, it is reasonable to assume the health of the user or other persons may be endangered.

Copyright Notice

Copyright © 2015 by Sensata Technologies. All rights reserved. Permission to copy, distribute, and/or modify this document is prohibited without express written permission from Sensata Technologies.

Document Information

Description – PT-100 Owner’s Manual
 Part Number and Revision – 64-0067 Rev A
 Date Published – June 2015

This manual is printed without color for cost savings. However, this entire manual is available for download—with many of the figures available in color—under the Document Library tab at www.Magnum-Dimensions.com.

Contact Information

For Magnum-Dimensions Products:

Sensata Technologies
 2211 West Casino Rd.
 Everett, WA 98204
 Phone: 425-353-8833
 Fax: 425-353-8390
 Web: www.Magnum-Dimensions.com

Record the unit’s serial number in case you need to provide this information in the future. It is much easier to record this information now, instead of trying to gather after the installation.	
Model:	Serial Number:
PT-100	TB-

Regulatory Compliance

The PT-100 is a MPPT charge controller with an internal GFDI (Ground Fault Detector/Indicator) and AFCI (ARC Fault Circuit Interrupter).

The PT-100 has been tested and listed to UL 1741, 2nd Edition (Standard for Charge Controllers, Converters and Controllers for use in Independent Power Systems) for use in the US; and is also certified to CSA C22.2 No. 107.1-01 (General Use Power Supplies) for use in Canada.

It has been tested and certified to these product safety standards by Intertek Testing Services (known as ETL), which is a Nationally Recognized Testing Laboratory (NRTL). NRTL's are qualified organizations that meet Occupational Safety and Health Administration (OSHA) regulations to perform independent safety testing and product certification.

EU Directives and Standards

The PT-100 charge controller meets the EMC requirements in the following product standards harmonized with the EMC Directive 2004/108/EC:

- EN 55014-1 (2006) +A1 (2009) +A2 (2011), Electromagnetic compatibility – Part 1: Emission.
- EN 55014-2 (1997) +A1 (2001) +A2 (2008), Electromagnetic compatibility – Part 2: Immunity.

FCC Information to the User

This equipment has been tested and found to comply with the limits for a Class B digital device, pursuant to Part 15 of the FCC Rules. These limits are designed to provide reasonable protection against harmful interference in a residential installation. This equipment generates, uses and radiates radio frequency energy and, if not installed and used in accordance with the instructions, may cause harmful interference to radio communications. However, there is no guarantee that interference will not occur in a particular installation. If this equipment does cause harmful interference to radio or television reception, which can be determined by turning the equipment off and on, the user is encouraged to try to correct the interference using one or more of the following measures:

- Reorient or relocate the receiving antenna.
- Increase the separation between the equipment and the receiver.
- Connect the equipment into an outlet on a circuit different from that to which the receiver is connected.
- Consult the dealer or an experienced radio/TV technician for help.

Abbreviations and Acronyms

AC	Alternating Current	MPPT	Maximum Power Point Tracking
AFCI	Arc-Fault Circuit Interrupter	NEC	US National Electrical Code NFPA-70
CEC	Canadian Electrical Code	PV	Photovoltaic
CSA	Canadian Standards Association	STC	Standard Test Condition
DC	Direct Current	UL	Underwriters Laboratories
ETL	Intertek Testing Services	VDC	Volts DC
FCC	Federal Communications Commission	VMP	Voltage at Maximum Power
GFDI	Ground Fault Detection/Indication	VOC	Open Circuit Voltage
LED	Light Emitting Diode	ISC	Short Circuit Current

IMPORTANT SAFETY INSTRUCTIONS

SAVE THESE INSTRUCTIONS

THIS MANUAL CONTAINS IMPORTANT INSTRUCTIONS FOR THE PT-100 MPPT CHARGE CONTROLLER THAT SHALL BE FOLLOWED DURING THE INSTALLATION AND OPERATION OF THIS PRODUCT.

Before using the PT-100, read all instructions and cautionary markings. Also, be sure to review the individual manuals provided for each component of the system. The installation instructions are for use by qualified personnel only. Do not perform any installation or servicing other than that specified in this owner's manual unless you are qualified to do so. Incorrect installation or servicing may result in a risk of electric shock, fire, or other safety hazard.

Safety Symbols

The following safety symbols have been placed throughout this manual to indicate potentially dangerous or important safety instructions.



WARNING: This symbol indicates that failure to take a specified action could result in physical harm to the user.



CAUTION: This symbol indicates that failure to take a specified action could result in damage to the equipment.



Info: This symbol indicates information that emphasizes or supplements important points of the main text.



GROUND: This symbol indicates the connection point intended for the equipment-grounding conductors, and is located in the wiring compartment.

Safety Precautions

- All electrical work must be performed in accordance with local and national electrical codes.
- This product is designed for indoor/compartment installation. It must not be exposed to rain, snow, moisture, or liquids of any type.
- There are no user-serviceable parts contained in this controller; do not disassemble or attempt to repair. Refer servicing to qualified service personnel.
- Since a charge controller utilizes PV power and batteries, power may be present at more than one point. To reduce risk of electric shock, ensure both battery and PV power are disconnected prior to performing maintenance. Turning off the charge controller will not reduce this risk, the charge controller must be totally disconnected from all sources of power.
- When exposed to sunlight, PV modules can generate current and voltage on its output wires/terminals. Before making any connections, de-energize the PV modules, either by removing them entirely from light or completely covering their front surface with an opaque (dark) material.
- Listed or labeled equipment shall be installed and used in accordance with any instructions included in the listing or labeling.
- Always verify proper wiring prior to starting the charge controller.
- Use only copper wires with a minimum temperature rating of 167°F (75°C).
- Torque all wire connections to the required torque values.
- The charge controller must be properly mounted and installed in a proper location. See Section 2.3 for information on mounting and location requirements.
- Overcurrent protection (i.e., fuses/circuit breakers) is not provided as an integral part of this charge controller. Overcurrent protection for the PV and battery wiring must be provided as part of the system installation.
- This device is provided with integral PV Ground Fault Detector/Interrupter (GFDI). Normally grounded conductors may be ungrounded and energized when a ground-fault is indicated.
- The heatsink of the controller can exceed 167°F (75°C); to reduce the risk of burns, do not touch.
- Internal capacitors may have stored energy. Once all sources of power has been disconnected, wait at least two minutes before removing the access cover.

Battery Safety

- Use insulated tools and be very careful when working around batteries, they can produce extremely high currents if short-circuited (e.g., dropping a metal tool across the battery terminal), which could cause a fire or explosion.
- Read and follow the battery manufacturer's safety precautions before installing the charge controller and batteries. Always verify proper polarity and voltage before connecting the batteries to the charge controller. Once the batteries are connected to the charge controller, ensure the maintenance and charging requirements (i.e., charge voltage and charge rate) provided by the battery manufacturer are followed to extend the life of the batteries and to prevent damage to the batteries while charging.
- Wear eye protection such as safety glasses, and avoid touching your eyes and face when working with batteries. Keep any fluid/corrosion on the battery from coming in contact with eyes and skin. Have plenty of fresh water and soap nearby and thoroughly wash in case battery acid contacts skin, clothing, or eyes. In the event of exposure to the eyes, flood them for at least 15 minutes with running water and seek immediate medical attention. Baking soda neutralizes lead acid battery electrolyte and vinegar neutralizes spilled NiCad and NiFe battery electrolyte; depending on your battery type, keep a supply on hand near the batteries.
- Remove all jewelry such as rings, watches, bracelets, etc., when installing or performing maintenance on the batteries and charge controller. A battery can produce a short-circuit current high enough to weld metal jewelry, causing severe burns.
- Never work alone. Always have someone within the range of your voice or close enough to come to your aid when working around batteries.
- Use proper lifting techniques when working with batteries.
- Never use old or untested batteries. Check each battery's label for age, type, and date code to ensure all batteries are identical.
- Batteries can produce explosive gasses, so install batteries in a well-ventilated area. For compartment or enclosure installations, always vent batteries from the highest point to the outside. Design the battery enclosure to prevent an accumulation and concentration of hydrogen gas in pockets at the top of the compartment.
- Provide at least one inch of air space between batteries to provide optimum cooling.
- Never smoke or allow a spark near batteries.
- To prevent a spark at the battery and reduce the chance of explosion, always connect the cables to the batteries first. Then connect the cables to the charge controller.
- Never charge a frozen battery.
- The battery bank should be installed in a clean, dry, ventilated environment where they are protected from high and low temperatures. The location must be fully accessible and protected from exposure to heat producing devices, and away from any fuel tanks.

CONSIGNES DE SÉCURITÉ IMPORTANTES CONSERVER CES INSTRUCTIONS

CE MANUEL CONTIENT DE IMPORTANTES POUR LA SÉRIE PT-100 ONDULEUR/CHARGEUR QUI DOIVENT ÊTRE SUIVIES PENDANT L'INSTALLATION ET FONCTIONNEMENT DE CE PRODUIT.

Avant d'utiliser la série PT-100, lire toutes les instructions et les mises en garde. Aussi, n'oubliez pas de passer en revue les différents manuels fournis pour chaque composant du système. Les instructions d'installation sont pour une utilisation par du personnel qualifié. Ne pas effectuer une installation ou d'entretien autres que ceux spécifiés dans ce manuel, sauf si vous êtes qualifié pour le faire. Une mauvaise installation ou d'entretien peut entraîner un risque de choc électrique, un incendie ou autre danger pour la sécurité.

Symboles de sécurité

Les symboles de sécurité suivants ont été placés tout au long de ce manuel pour indiquer des conditions dangereuses et les consignes de sécurité importantes.



AVERTISSEMENT: Ce symbole indique que le défaut de prendre une action spécifiée pourrait causer des dommages physiques à l'utilisateur.



ATTENTION: Ce symbole indique que le défaut de prendre une action spécifiée peut entraîner des dommages à l'équipement.



Info: Ce symbole indique une information qui met l'accent ou des suppléments importants du texte principal.



Ground: Ce symbole indique la terminaison pour le raccordement de conducteurs à la terre, et se trouve dans le compartiment de câblage.

Consignes de sécurité

- Tous les travaux électriques doivent être effectués en conformité avec les codes locaux et nationaux électriques.
- Ce produit est conçu pour l'installation / du compartiment intérieur. Il ne doit pas être exposé à la pluie, la neige, l'humidité ou des liquides de tout type.
- Il n'y a pas de pièces réparables par l'utilisateur contenues dans ce contrôleur, ne pas démonter ou tenter de réparer. Confiez l'entretien à du personnel qualifié.
- Depuis un contrôleur de charge utilise des batteries et la puissance PV, l'énergie peut être présente à plus d'un point. Pour réduire les risques de choc électrique, assurez-vous à la fois la batterie et la puissance PV sont débranchés avant d'effectuer l'entretien. La désactivation du régulateur de charge ne sera pas réduire ce risque, le régulateur de charge doit être totalement déconnecté de toutes les sources d'alimentation.
- Côté ou étiquetés équipement doit être installé et utilisé conformément aux instructions figurant dans la liste ou l'étiquetage.
- Toujours vérifier le câblage avant de commencer l'onduleur.
- Utilisez uniquement des câbles en cuivre avec une cote de température minimale de 167 ° F (75°C).
- Serrer toutes les connexions pour les valeurs de couple requis.
- Le régulateur de charge doit être correctement monté et installé dans un endroit approprié. Voir la section 2.3 pour obtenir des informations sur le montage et les exigences de localisation.
- Protection contre les surintensités (c.-à-fusible / disjoncteur) n'est pas prévue comme faisant partie du régulateur de charge. Protection contre les surintensités pour les PV et câblage de la batterie doit être fournie dans le cadre de l'installation du système.
- Ce contrôleur est fourni avec PV Rez détecteur / interrupteur de défaut intégrale (GFDI). Normalement conducteurs mis à la terre ne peuvent pas être connectés électriquement à la masse et peuvent être alimentés dans le cas d'un défaut à la terre est indiquée.
- Certaines surfaces de la contrôler peuvent dépasser 167°F (75°C), de réduire le risque de brûlures, ne pas toucher.
- Condensateurs internes peuvent avoir stocké l'énergie. Ne pas retirer couvercle jusqu'à ce que 2 minutes après déconnectant toutes les sources d'énergie .

Sécurité de la batterie

- Utiliser des outils isolés et être très prudent lorsque vous travaillez près des batteries, elles peuvent produire des courants extrêmement élevés si en court-circuit (par exemple, échapper un outil métallique à travers la borne de la batterie), ce qui pourrait provoquer un incendie ou une explosion.
- Lisez et suivez les consignes de sécurité du fabricant de la batterie avant d'installer l'onduleur et des batteries. Toujours vérifier la polarité et la tension avant de brancher les batteries à l'onduleur. Une fois que les batteries sont connectées à l'onduleur, assurer la maintenance et les exigences de charge (c.-à-tension de charge et taux de charge) fournis par le fabricant de la batterie sont suivies pour prolonger la vie des batteries et pour éviter d'endommager les batteries pendant la charge.
- Porter des lunettes de protection tels que des lunettes de sécurité, et évitez de toucher vos yeux et le visage lorsque l'on travaille avec des piles de garder tout fluide / corrosion sur la batterie d'entrer en contact avec les yeux et la peau. Ayez suffisamment d'eau fraîche et de savon à proximité et se laver dans le cas d'acide contact avec la peau de la batterie, les vêtements ou les yeux. Dans le cas d'exposition pour les yeux, les inonder pendant au moins 15 minutes à l'eau courante et consulter immédiatement un médecin. Le bicarbonate de soude neutralise l'acide de plomb électrolyte de la batterie et le vinaigre neutralise renversé NiCad et NiFe batterie à électrolyte; en fonction de votre type de batterie, gardez sous la main près des batteries.
- Enlevez tous les bijoux tels que bagues, montres, bracelets, etc, lors de l'installation ou la maintenance sur les batteries et l'onduleur. Une batterie peut produire un court-circuit assez de courant élevé pour souder les bijoux en métal, provoquant de graves brûlures.
- Ne jamais travailler seul. Toujours avoir quelqu'un au sein de la gamme de votre voix ou suffisamment près pour vous venir en aide lorsque vous travaillez près des batteries.
- Utiliser des techniques de levage appropriées lorsque vous travaillez avec des piles.
- Ne jamais utiliser de piles usagées ou non testés. Vérifiez l'étiquette de chaque batterie à l'âge, le type et le code de date afin d'assurer toutes les batteries sont identiques.
- Batteries sensibles aux changements de température. Toujours installer dans un environnement stable.
- Les batteries peuvent produire des gaz explosifs, etc installer les piles dans un endroit bien ventilé. Pour les installations compartiment ou une enceinte, toujours évacuer les piles du plus haut point à l'extérieur. Concevoir le boîtier de piles pour éviter l'accumulation et la concentration de gaz d'hydrogène dans "poches" en haut du compartiment.
- Fournir au moins un pouce de l'espace aérien entre les batteries pour fournir un refroidissement optimal.
- Ne jamais fumer ou laisser une étincelle près des batteries.
- Pour éviter une étincelle à la batterie et de réduire le risque d'explosion, toujours connecter les câbles aux batteries en premier. Ensuite, connectez les câbles à l'onduleur.
- Ne jamais charger une batterie gelée.
- La banque de la batterie doit être installé dans un endroit propre, sec, aéré et où ils sont protégés contre les températures élevées et basses. L'emplacement doit être pleinement accessible et protégé contre l'exposition à la chaleur la fabrication de dispositifs, et loin de toute réservoirs de carburant.

Table of Contents

Disclaimer of Liability	i
Restrictions on Use	i
Copyright Notice	i
Document Information	i
Contact Information.....	i
Regulatory Compliance.....	ii
EU Directives and Standards	ii
FCC Information to the User	ii
Abbreviations and Acronyms	ii
IMPORTANT SAFETY INSTRUCTIONS	iii
CONSIGNES DE SÉCURITÉ IMPORTANTES.....	v
1.0 Introduction	1
1.1 Key Features and Benefits.....	1
1.2 Physical Features	2
2.0 Installation	5
2.1 Pre-Installation.....	5
2.2 PV System Components.....	6
2.3 Locating and Mounting the PT Controller	7
2.4 Electrical System Wiring Diagrams	16
2.5 PV Voltage Requirements	17
2.6 Conductor Sizing for the PV System	23
2.7 Wiring the PT-100.....	32
2.8 Wiring the Battery Temperature Sensor	39
2.9 Wiring the Auxiliary Relay	40
2.10 Network Wiring	41
2.11 Final Inspection/Tests.....	43
3.0 Setup	45
3.1 Adjust DIP Switch Settings.....	45
4.0 Operation	48
4.1 PT Front Panel Features	48
4.2 Front Panel Operation.....	49
4.3 MPPT Operation	54
4.4 Charger Control Operation	55
4.5 Ground Fault Detection and Interruption (GFDI) Operation	57
4.6 Arc-Fault Protection Operation	58
4.7 Battery Temperature Sensor Operation	59
4.8 Charge Controller Fan Operation	60
4.9 PowerSave Operation	60
4.10 Auxiliary Relay Operation.....	61
4.11 Internal Beeper Operation.....	61
4.12 Operating Configuration - Standalone vs Networked	62
5.0 Maintenance and Troubleshooting.....	63
5.1 Periodic Maintenance.....	63
5.2 Basic Troubleshooting.....	64
5.3 Troubleshooting Based on Fault Codes	64
5.4 Removing/Replacing the GFDI Fuse	68
5.5 Removing and Replacing the Electronics Section	69
5.6 Resetting the PT-100 Charge Controller	70

Table of Contents (*continued*)

Appendix A – Specifications and Optional Equipment	71
A-1 PT-100 Charge Controller Specifications	71
A-2 Performance Graphs.....	72
A-3 Optional Equipment and Accessories.....	73
Appendix B – Charge Controller Terminology	74
Appendix C – PV Conductor and OCPD Sizing Worksheet.....	76
Appendix D – Warranty and Service Information	78
D-1 Limited Warranty	78
D-2 How to Receive Repair Service.....	78

List of Figures

Figure 1-1, Front Features	2
Figure 1-2, Internal Features	3
Figure 1-3, Side Features	4
Figure 2-1, Simplified PV System	6
Figure 2-2, Removing the Access Cover	7
Figure 2-3, Removing Knockouts	7
Figure 2-4, PT-100 Dimensions and Knockout Locations	8
Figure 2-5, Mounting Orientations.....	9
Figure 2-6, Air Flow in and around PT.....	10
Figure 2-7, Minimum Mounting Clearance Requirements	10
Figure 2-8, Mounting the PT-100 Controller on a Magnum Panel.....	11
Figure 2-9, Holes Used to Mount Bracket on MMP Enclosure	12
Figure 2-10, Mounting Bracket Thru-hole Callouts	13
Figure 2-11, PT Controller Mounting Holes	14
Figure 2-12, Surface-mounting the PT-100 Controller	15
Figure 2-13, Mounting Bracket Dimensions (Each)	15
Figure 2-14, PT-100 Controller - System Wiring	16
Figure 2-15, Standalone PV System Circuits	23
Figure 2-16, Ground Fault Label	36
Figure 2-17, Wiring to DC Terminal Block.....	37
Figure 2-18, Battery Temperature Sensor	39
Figure 2-19, BTS and Battery Cable Hardware Installation.....	39
Figure 2-20, Auxiliary Relay Connections and Example	40
Figure 2-21, NETWORK Communication Cable (300V Rated).....	41
Figure 2-22, Extension Cable (300V Rated)	41
Figure 2-23, Connecting the PT-100 to the Magnum Inverter	42
Figure 2-24, Power-up Test Displays.....	44
Figure 3-1, DIP Switch Summary	45
Figure 4-1, Front Panel Display and LED Indicators	48
Figure 4-2, Scroll Sequence of Screens.....	49
Figure 4-3, Charge Status Indicators.....	50
Figure 4-4, Hard Fault Conditions.....	52
Figure 4-5, Soft Fault Conditions.....	52
Figure 4-6, Aux Relay indicator.....	52
Figure 4-7, SELECT and RESET Pushbuttons.....	53
Figure 4-8, I-V Curve	54
Figure 4-9, Automatic 3-Stage Charging Graph.....	55
Figure 4-10, Start/Stop Equalize Charge	57
Figure 4-11, AFP Test Switch.....	58
Figure 4-12, BTS Temperature to Charge Voltage Change.....	59
Figure 4-13, Power Save Indication	60
Figure 5-1, GFDI Fuse Location (Access Cover Removed)	68
Figure 5-2, Electronics Section Removal	69
Figure 5-3, PT Controller Reset.....	70
Figure A-1, Ambient Temperature vs Continuous Current Curve	72
Figure A-2, Output Current vs Battery Voltage Curve.....	72
Figure A-3, Maximum Power vs MPP Voltage Curve.....	73

List of Tables

Table 2-1, PV Input Voltage Parameters	17
Table 2-2, Allowable Conductor Ampacities.....	30
Table 2-3, Ambient Temperature Adjustments	30
Table 2-4, Rooftop Distance Adjustments	31
Table 2-5, Multiple Conductors in Raceway/Cable Adjustments.....	31
Table 2-6, Torque Values for the DC Terminal Block	33
Table 2-7, Torque Values for the Ground Busbar.....	33
Table 2-8, Recommended DC Wire/Overcurrent Device for PT-100.....	34
Table 2-9, Equipment Grounding Conductor Sizing	35
Table 2-10, Remote Compatibility Revision	42
Table 3-1, Battery Type to Charge Voltages	46
Table 4-1, Charge Status LED Indicators	50
Table 4-2, Power Status Code Descriptions.....	51
Table 4-3, Controller Settings (Standalone vs Networked)	62
Table 5-1, Basic Controller Troubleshooting (Remote not available).....	64
Table 5-2, Fault Code Descriptions	64

1.0 Introduction

Congratulations on your purchase of the PT-100 Charge Controller. The PT-100 is a Maximum Power Point Tracker (MPPT) charge controller specifically designed to harvest the maximum available energy from the PV array and deliver it to the batteries. The MPPT algorithm in the PT-100 is designed to find the maximum power point of the array and to operate at this point while regulating the output current and battery voltage to fully charge the battery. The PT-100 is simple to use and reliable, providing maximum flexibility in sizing your PV array and charging different battery types.

1.1 Key Features and Benefits

The PT-100 charge controller includes the following key features and benefits:

- Maximum Power Point Tracking technology for increased PV power output efficiency.
- Continuous charging current up to 100ADC and high input voltage up to 240VDC (Voc).
- Integrated PV Ground-Fault Detection and Interruption/Indication (GFDI), with pre-fault leakage/diagnostic metering.
- Multi-stage charging algorithms (automatic bulk, absorption and float, with manual equalization) to maximize system performance and improve battery life. Suitable for various types of batteries including flooded, AGM, and GEL batteries.
- Automatic battery temperature compensation using an external temperature sensor (included) for optimum battery charging, even during extreme temperature changes.
- Extensive electronic protection: Over-temperature protection, power derating when temperature is high, PV short circuit and high PV input shutdown, output overcurrent protection and night-time back-feed (reverse current) protection.
- Compatible with 12, 24 or 48V battery systems with automatic detection of system voltage
- Single controller supports large PV array up to 6600W.
- Peak conversion efficiency is higher than 99% (PV In to DC Out).
- Low self-consumption (<4W) - in night-time mode.
- Built-in programmable auxiliary relay for device control (requires remote).
- Internal data logging functionality keeps energy harvest information and battery Ahr/Whr data up to 255 days (requires remote to display).
- Multiple LED indicators and large digital LED screen on front panel provides charger and fault status information and important system information (PV power input, PV voltage input, battery voltage and battery current).
- Easy setup with "link" feature and no more incompatibility issues between the charge controller settings and the inverter charge settings—when networked with a Magnum inverter system.
- Integrated PV Arc-Fault Circuit Interrupter (AFCI) that will detect, extinguish, and indicate series arcs. Designed to meet the new National Electric Code (NEC) Article 690.11 requirements.
- Remain-in-place wiring box design to prevent the removing of conduit/wiring if service required. Can also be used to pre-install conduit and wires before electronic section install.
- Listed to UL1741 (for US) and certified to CSA (for Canada) and CE (for Europe) standards.
- Ability to update software onsite.
- Designed to work with a Magnum Panel (MP) or Mini-Magnum Panel (MMP) - provides room and access to PV and battery disconnect breakers.



Info: This is a comprehensive manual and much of it is fairly technical. Terms may be used throughout the manual that are unfamiliar to you. Refer to the glossary in Appendix B for clarification.

1.2 Physical Features

The PT-100 charge controller is designed to allow easy access to wiring, circuit breakers, and controls. Its die cast baseplate with two-piece cover ensures maximum durability with minimum weight for more efficient operation.

As shown in Figure 1-1, the front of the PT-100 charge controller is equipped with the following:

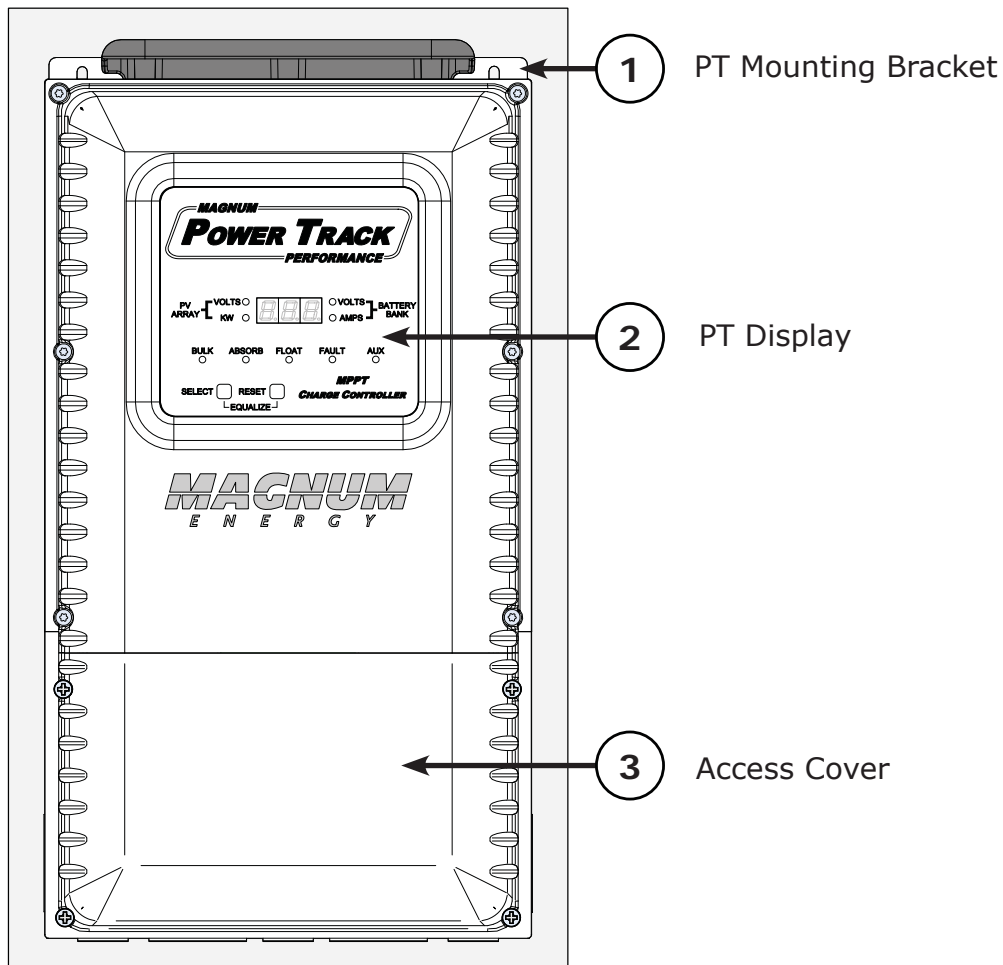

Figure 1-1, Front Features

- 1 **PT Mounting Bracket** – used to secure the charge controller to a wall or to a Magnum panel. See Section 2.3 for information on locating and mounting the PT controller.
- 2 **PT Display** – LED display and indicators illuminate to provide information on charge controller operation. See Section 4.0 for information on the PT display's operation.
- 3 **Access Cover** – under the removable front access cover is the DC wiring terminal, the switches used for configuring the PT-100, and the cable connection ports to connect accessories. See Section 2.3.1 for information on how to remove this cover to access the compartment.

The PT controller is equipped with the following features (under the access cover) see Figure 1-2):

- 4 **DIP Switch** – this Dual In-line Package (DIP) switch determines the different operating features of the PT Series. See Section 3.0 for information on configuring this switch.
- 5 **ARC Fault Test Button Switch** – designed to be a momentary button switch that allows the user to test the ARC Fault circuit. See Section 4.6.1 for information on this switch.
- 6 **Auxiliary (Aux) Relay Connection Terminal** – a 3-port terminal block to allow connection to an internal aux relay. Requires a remote control for programming. See Section 2.9 for information on how to wire and set up the Aux Relay.
- 7 **DC Terminal Block** – a 4-port terminal block to connect the PV and battery wires. See Section 2.7.8 and 2.7.9 for information on wiring to this terminal block.
- 8 **Ground Fault Fuse** – this is the fuse for the Ground Fault Detection Interrupter (GFDI) circuitry. See Section 5.5 for information on replacing this fuse.
- 9 **Ground Busbar** – this ground busbar is connected to the PT controller chassis and is used to tie the DC equipment grounds to a common point (refer to Figure 2-17).
- 10 **Wiring Box** – the DC wiring box provides the location for making the PV, battery and ground connections, and includes knockouts to accommodate and secure the input and output field wiring. This wiring box has also been designed to remain in place if the PT-100 requires service (refer to Section 5.6).
- 11 **Dual Stack Ports** – feature currently not available. These two RJ45 ports are provided to allow controller stacking when enabled in the future.
- 12 **Network Connection Port (green label)** – a RJ11 port that allows the PT-100 to network to a Magnum inverter. See Section 2.10 for information on networking.
- 13 **BTS Connection Port (yellow label)** – a RJ11 port that allows the Battery Temperature Sensor (BTS) to connect to the PT-100. See Section 2.8 for information on the BTS.

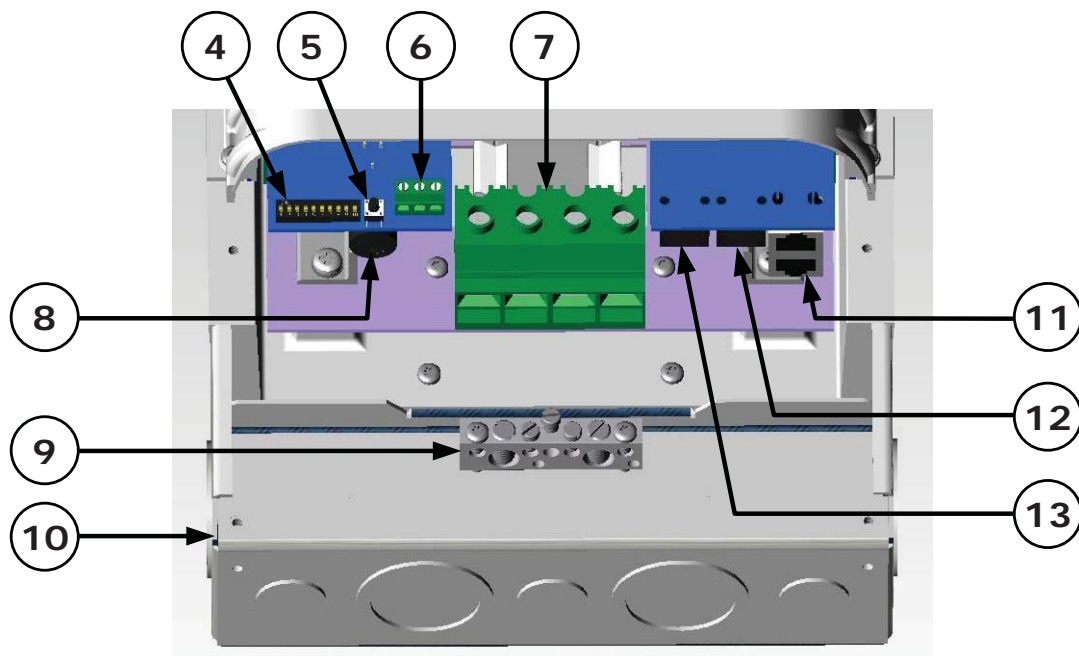

Figure 1-2, Internal Features

The sides of the PT-100 charge controller are equipped with the following (Figure 1-3):

- 14 **CE Label** – This label means the controller has been tested and conforms to applicable EC directives for emission and immunity—allowing this controller to be sold in Europe.
- 15 **Model/Serial Number Label** – on the left side of the controller is the Model/Serial Number label. This label provides model, UL/CSA listings, serial number information, date of manufacture, and charge controller specifications. See the PT-100 specifications in Appendix A for more information.
- 16 **Safety Label** – on the right side of the controller is the safety label. This label provides information to the user to help prevent risk of electric shock, fire, or other safety hazard.
- 17 **Side Knockouts** – dual 1" and 1¼" knockouts provided on each side of the DC wiring box for field wiring. See 2.3.2 before removing knockouts.

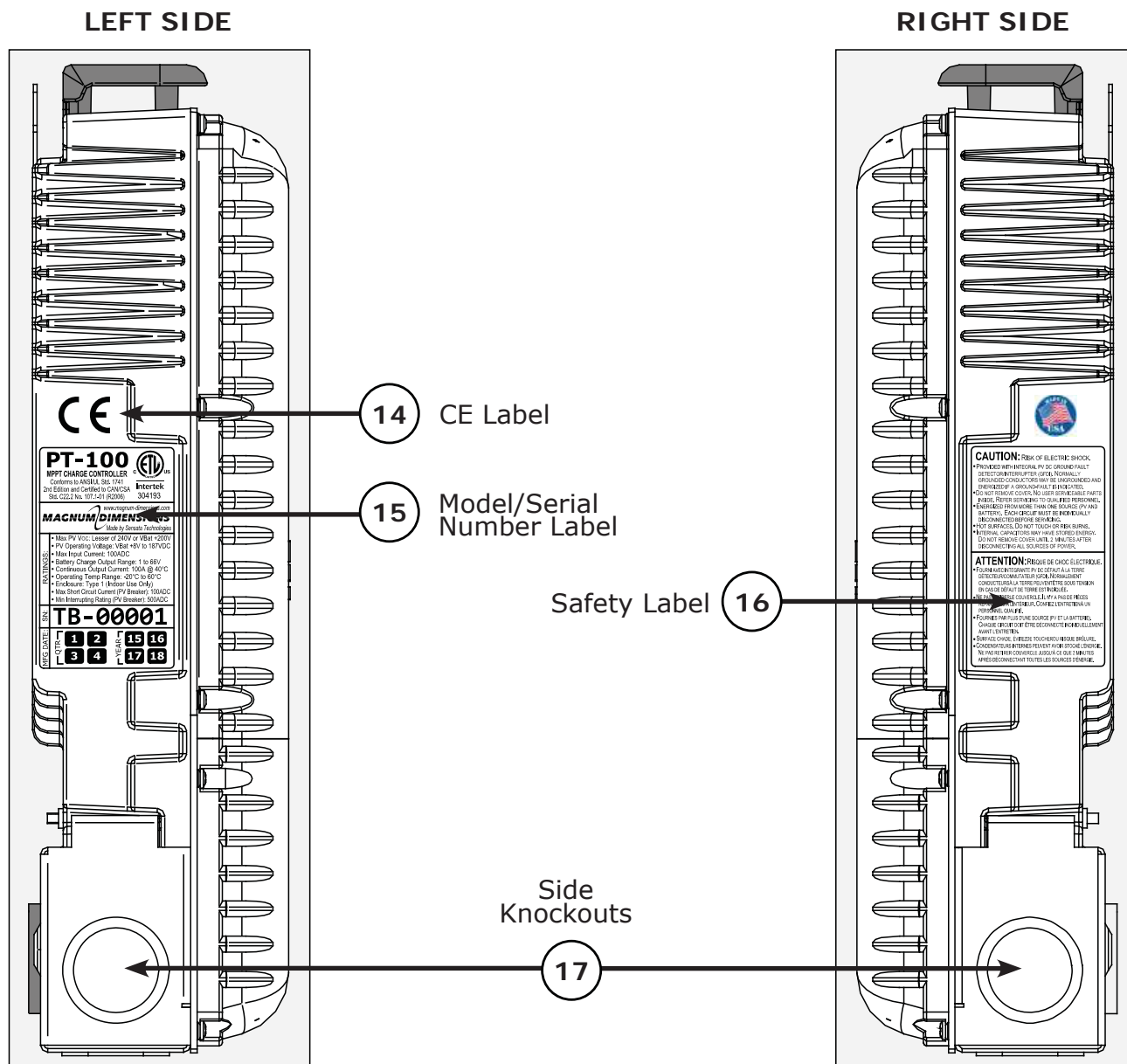

Figure 1-3, Side Features

2.0 Installation



WARNING: All installations must be performed in compliance with any applicable local codes and, with the National Electrical Code (NEC), ANSI/NFPA 70 - for US installations, or with the Canadian Electrical Code (CEC), CSA C22.1 - for Canadian installations.



WARNING: Installations should only be performed by authorized personnel. These are qualified electricians and technicians who are familiar with solar system design and wiring practices. It is the installer's responsibility to determine which safety codes apply and to ensure that all applicable installation requirements are followed. Applicable installation codes vary depending on the specific location and application of the installation.



WARNING: Whenever exposed to sunlight at any intensity, PV modules can generate current and voltage on its output wires/terminals. Working with PV circuits while the PV system is exposed to light can result in lethal electric shock. Before making any connections, de-energize the PV modules, either by removing them entirely from light or completely covering their front surface with an opaque (dark) material.



CAUTION: Review the "Important Safety Instructions" on pages iii-vi before installing the PT-100.

2.1 Pre-Installation

Before proceeding with the physical installation, read this entire Installation section to determine how best to install your PT-100 charge controller. Also, review the installation instructions for each component in the PV installation. The more you thoroughly plan in the beginning and become familiar with all the components in the installation, the better the chances are that the actual installation process will occur without incident.

2.1.1 Unpacking and Inspection

Carefully remove the PT-100 charge controller from its shipping container and inspect all contents. Verify the following items are included:

- PT-100 Charge Controller
- Battery Temperature Sensor (15')
- PT-100 Owner's Manual
- Ground Fault Warning Label
- 6' Network Communication Cable (300V)
- 6' Extension Cable (300V)
- Back-mount Bracket (2 pieces) with 4 screws

If items appear to be missing or damaged, contact your authorized dealer or Sensata. If at all possible, keep your shipping box to help protect your charge controller from damage if it ever needs to be returned for service.

Important: Save your proof-of-purchase as a record of your ownership; it will be required if the PT-100 should require in-warranty repair.

Record the unit's serial number in the front of this manual in case you need to provide this information in the future. It will probably be easier to record this information now, instead of trying to gather it after the unit has been installed.

2.1.2 Required Tools and Materials

Hardware/Materials

- Conduit, strain-reliefs and appropriate fittings
- Electrical tape
- 1/4" mounting bolts and lock washers
- Wire ties

Tools

- #2 Phillips screwdriver
- Drill and drill bits
- #2 -3 Slotted screwdriver
- Level
- Pliers
- Pencil or marker
- Torque wrench
- Wire strippers
- Multimeter
- Hammer

2.2 PV System Components

A simple diagram of a typical stand-alone Photovoltaic (PV) system is illustrated in Figure 2-1. This diagram will help identify the PV system components used with a stand-alone controller.

- PV Array - made up of PV modules and provides DC (solar) power to the PT-100 controller.
- PV Strings - an assembly of modules in series that generates DC power at system voltage.
- PV String Combiner - provides a connection point for multiple PV circuit conductors that need to be connected. Also provides a convenient location for the required overcurrent protection.
- System disconnects (breakers) - used to safely isolate the system equipment from sources of electricity for system maintenance/troubleshooting. The disconnect can be a circuit breaker, which also provides the required overcurrent protection.
- PT-100 MPPT Charge Controller - utilizes the available maximum power output from the array to charge and maintain the battery bank.
- Battery Bank - energy storage to provide power at night or on overcast days when the PV array cannot generate the power needed.
- Standalone inverter (with an internal battery charger) - converts DC power from the battery bank to AC (Alternative Current) power, to allow downstream AC loads to be powered.

Note: A standalone inverter is not a grid interactive (also known as utility-interactive) inverter and it does not have the ability to export (or sell) power back to the utility grid.

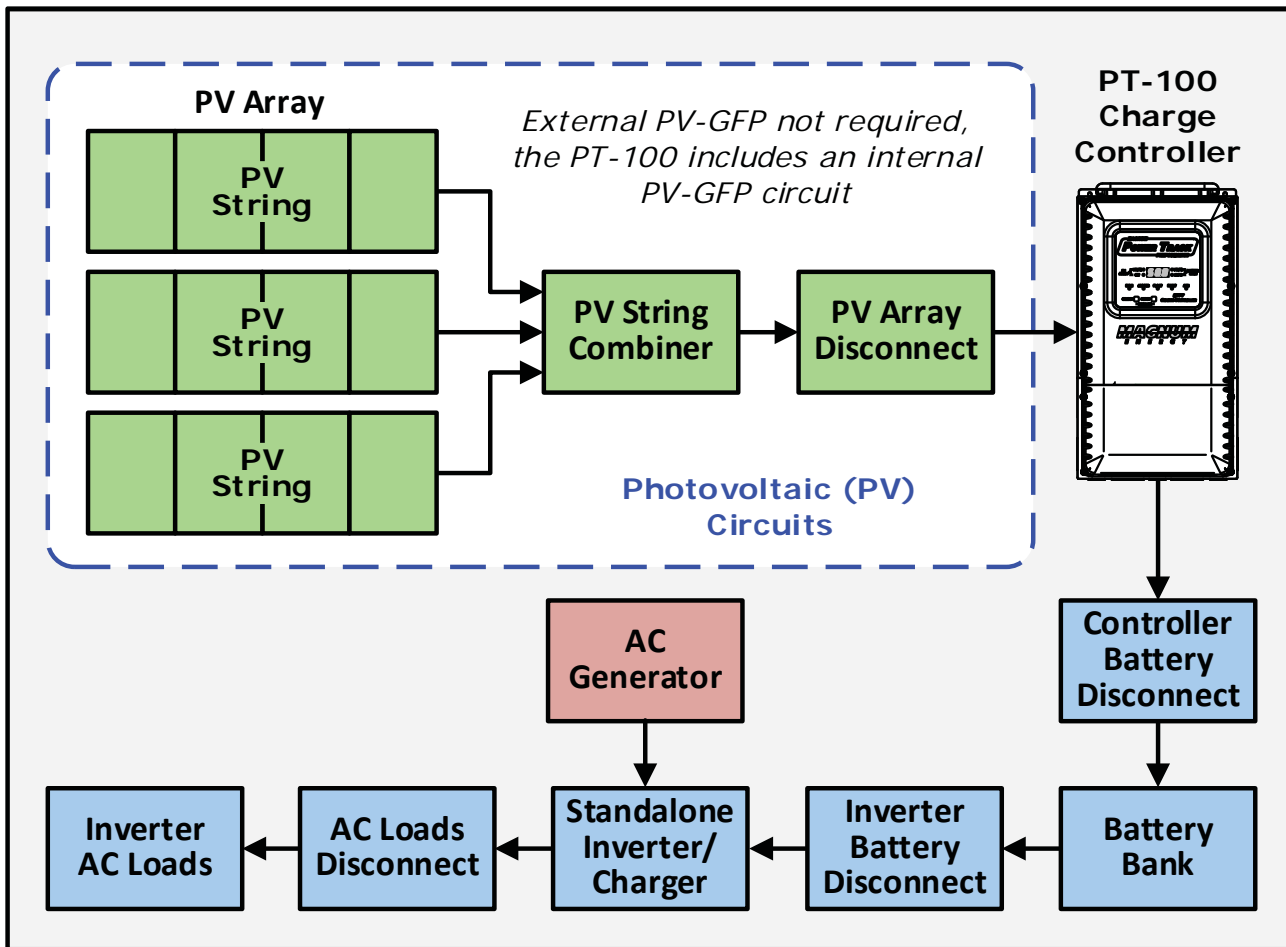

Figure 2-1, Simplified PV System

2.3 Locating and Mounting the PT Controller

2.3.1 Removing the Access Cover

Before mounting, use a #2 Phillips screwdriver to remove the wiring compartment access cover to expose the mounting holes and wiring terminals. The access cover is secured to the front of the controller with four Phillips #8-32 x 3/8" (9.5 mm) screws as shown in Figure 2-2 below.



CAUTION: To prevent injury, ensure all PV and battery power to the controller is disconnected before removing the access cover.

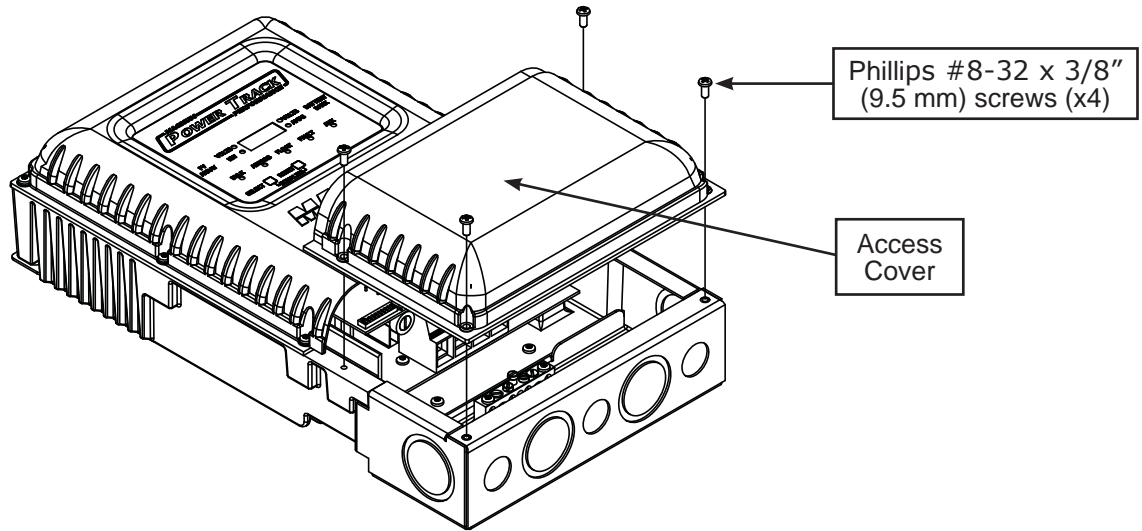

Figure 2-2, Removing the Access Cover

2.3.2 Removing Knockouts

The wiring box on the PT charge controller provides four dual (1 and 1¼") and three single (½") knockouts. These knockouts are provided for routing battery, PV array, BTS, and network cables into the PT charge controller. Figure 2-4 shows the location of these conduit knockouts.

Before removing the knockouts and mounting the PT controller, think about all the different wiring requirements and select the knockout closest to the terminal to which the wire connects, or whichever one works for the way your conduit or field wiring comes in. Refer to Section 2.7.2.

As shown in Figure 2-3, the knockouts can be easily removed by tapping the edge with a straight bladed screwdriver and a hammer, then twist out with pliers. Do not drill, cut, or punch holes in the PT charge controller. Use only the knockouts provided. While removing, ensure that no metal shavings or fragments fall into the wiring compartment.

After removing the knockouts, use bushings or conduits to protect the wiring from damage from rough edges around the knockout holes.

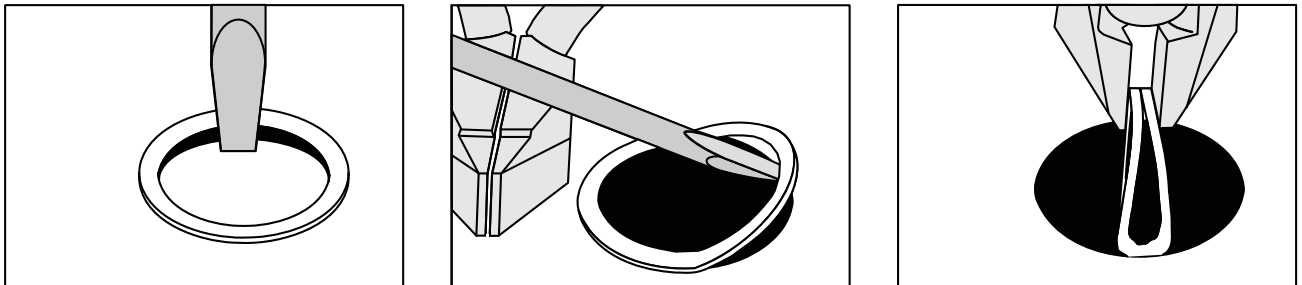

Figure 2-3, Removing Knockouts

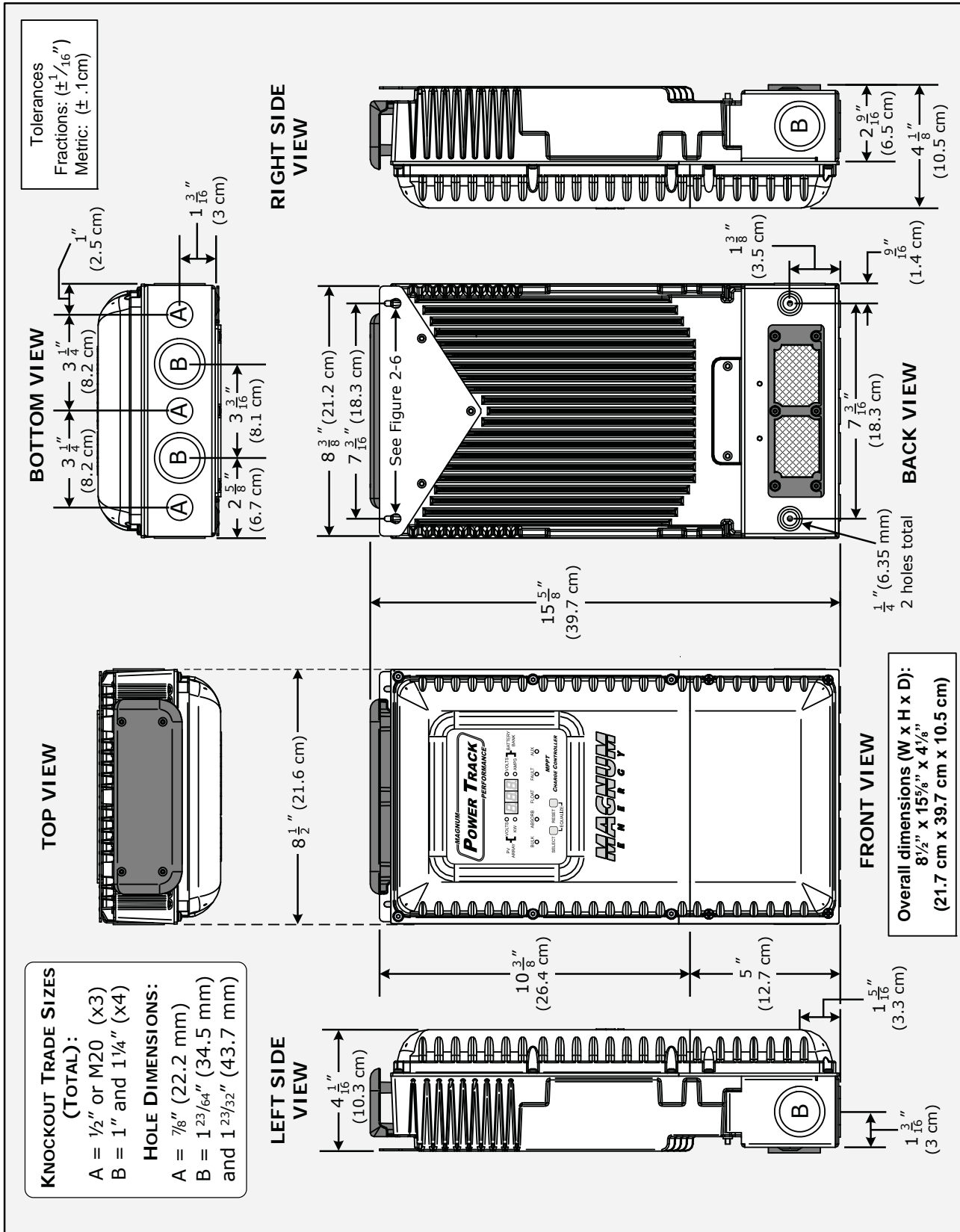

Figure 2-4, PT-100 Dimensions and Knockout Locations

2.3.3 Finding a Location

The location of the PT controller is important to its performance and operating life. Install it in a location that meets the following requirements:

Cool – The charge controller should be protected from direct sun exposure or anything that could raise its temperature (e.g., near a heating duct). To meet full power specifications, the ambient temperature around the charge controller should not exceed 77°F (25°C).

Dry – The PT charge controller enclosure is rated for indoor use only. The area where it is located must be free from any risk of condensation, water, or any other liquid that can enter or fall on the charge controller. The charge controller uses stainless steel and zinc plated fasteners, a powder-coated aluminum base, and the internal circuit boards are conformal coated—to help fight the harmful effects of corrosion. However, the controller’s life is uncertain if used in a corrosive environment, and failure due to corrosion is not covered under warranty.



Info: As a preventive measure to help protect and preclude corrosion to the electrical ports on the PT-100 controller, silicone dielectric grease compound can be applied into the RJ11/RJ14 connections (Items 11, 12, and 13 as shown in Figure 1-2). Before installing the cables, or if leaving any ports open, squirt a liberal amount of silicone dielectric compound into each port to make an effective moisture and corrosive barrier.

Safe – Keep any flammable/combustible material (e.g., paper, cloth, plastic, etc.,) that may be ignited by heat, sparks, or flames at a minimum distance of 2 feet (61 cm) from the controller.

Close to the battery bank – The charge controller should be located as close to the batteries as possible - long DC wires tend to reduce the overall charging performance from the charge controller to the battery bank. However, the unit should not be installed in the same compartment as the batteries or mounted where it will be exposed to gases produced by the batteries. These gases are corrosive and will damage the charge controller; also, if these gases are not ventilated and allowed to collect, they could ignite and cause an explosion.

Accessible – Do not block access to the front of the charge controller, or prevent the ability to view the charge controller’s display and status indicators. Allow enough room to remove the access cover to work with the wiring terminals and connections, as they will need to be checked and tightened periodically.

2.3.4 Mounting Orientation

The PT-100 must be mounted vertically with the wiring box towards the bottom and its heatsink fins oriented vertically to benefit from convection cooling—DO NOT tilt. If not mounted vertically, the average output power will be automatically reduced to help prevent an over-temperature shutdown.

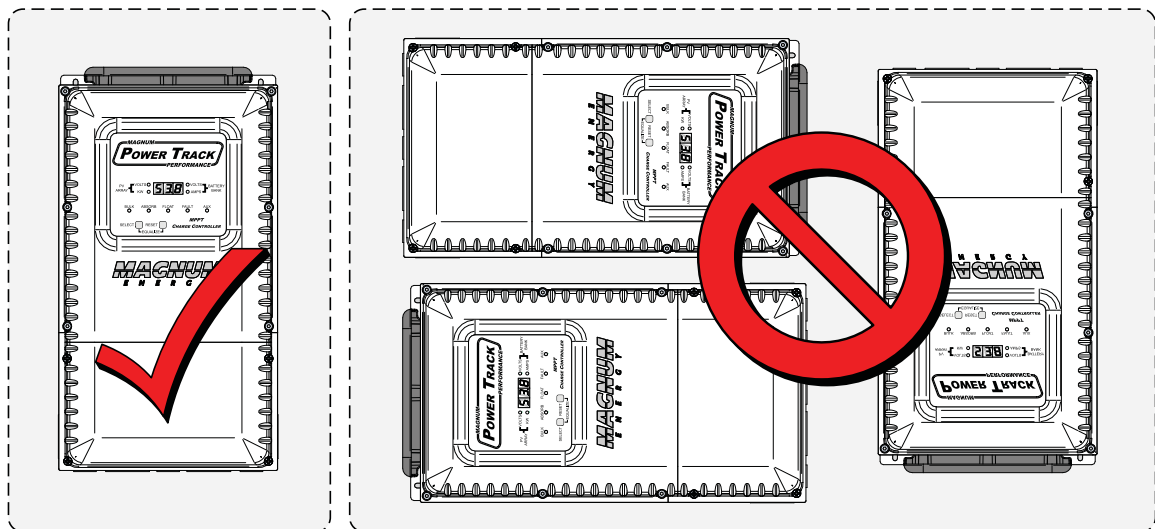

Figure 2-5, Mounting Orientations

2.3.5 Ventilation and Clearance Requirements

The charge controller should not be installed in an area that allows dust, debris, insects or rodents to enter or block the controller's ventilation openings, or in an area without sufficient air flow around the PT's enclosure. There must be free air movement through the controller and over the controller's rear heatsink fins. This is done by mounting on the side of a Magnum Panel (see Figure 2-8 or by using the supplied wall-mounting bracket to mount against a wall (see Figure 2-10).

The PT-100 controller uses two fans to force air through the controller to help maintain the proper internal operating temperature. The fans pull in air through the intake vents and blow out air through the exhaust vents (see Figure 2-6). In order for the PT-100 to provide full output power and to avoid over-temperature fault conditions, do not cover or block the ventilation openings or install this charge controller in an area with limited airflow. When mounting the controller, ensure there is free air flow through the controller and adequate clearance around the rear heatsink fins. To provide adequate ventilation, allow at the minimum, a clearance of 6" (15 cm) from the bottom surface and 1" (5 cm) from the rear and at least 1" (2.5 cm) from one of the side surfaces (see Figure 2-7).



CAUTION: Do not mount this charge controller flush against any surface without using the wall-mounting bracket that is provided. Damage to the surface and over-temperature shutdowns may occur, and service life of the controller may be affected.



CAUTION: Do not mount this charge controller in a zero clearance compartment, nor cover or obstruct the ventilation openings—overheating will result.



Info: If required, the controller may be installed in an enclosure, as long as it is ventilated with sufficient air flow. The enclosure must have a fresh air intake opening provided directly to the side of the controller close to the intake vents and an exhaust opening close to the exhaust vents on the charge controller. This allows cool air from the outside to flow in and heated air to exit out of the PT-100 and the enclosure.

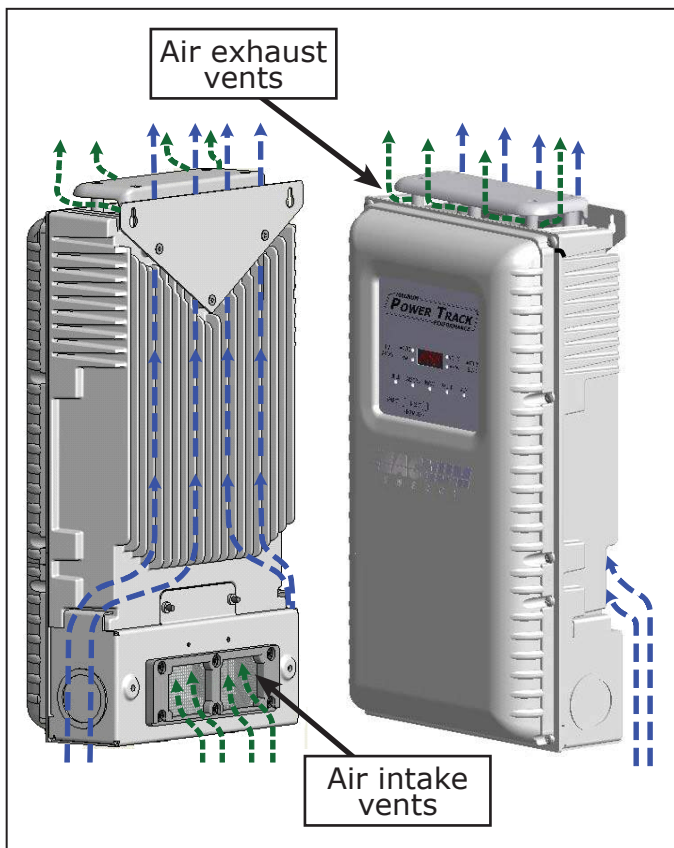

Figure 2-6, Air Flow in and around PT

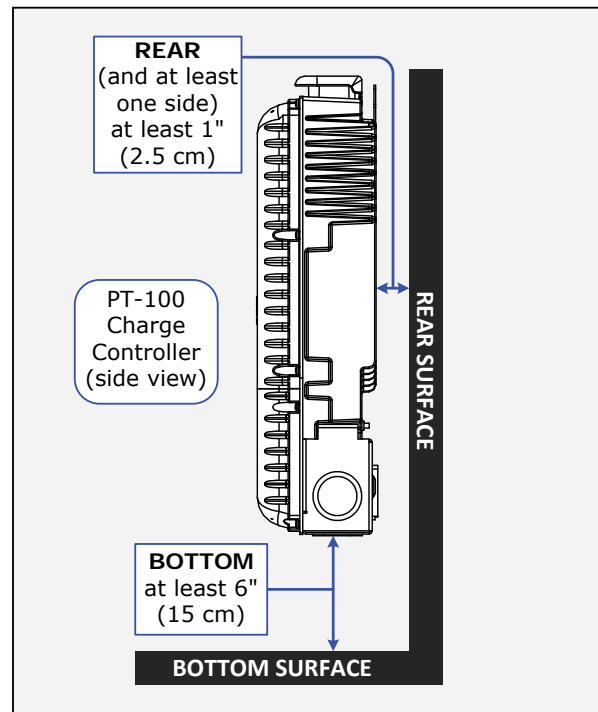

Figure 2-7, Minimum Mounting Clearance Requirements

2.3.6 Mounting Methods

Two mounting methods are available for the PT-100. The first method allows the controller to be mounted next to a Magnum Panel (i.e., MP or MMP), aligning the conduit openings (see Figure 2-8). The second mounting method uses two brackets on the top and bottom of the controller for mounting directly on a wall and is normally used in a standalone installation (see Figure 2-10).

2.3.6.1 Mounting the Charge Controller on a Magnum Panel

Use the following steps to mount the PT controller on a Magnum panel:

1. Mount the charge controller bracket (MP-CCB) on either side of a MP or MMP panel. The keyhole slots on the back of the controller will be used to attach to the charge control bracket, see the Section 2.3.6.1.1 to install the bracket on a Magnum panel.
2. Remove the 1¼" conduit knockout in the Magnum panel that corresponds with the conduit knockout in the PT controller.
3. Use a 2" close nipple (with 1¼" openings) for the wire run between the Magnum panel and the PT controller. Align one end of the nipple with lock nuts and insulator cap through the side knockout opening in the panel and the other end thru the knockout opening in the controller.



Info: It may take three locknuts on the close nipple to anchor the controller to the enclosure. An additional locknut may be required between the enclosure and the controller to act as a spacer. Also, a standard one inch plastic bushing should be used on the nipple ends to protect the wire insulation as it enters/exits the nipple.

4. Ensure the PT controller is secured to the MP panel.

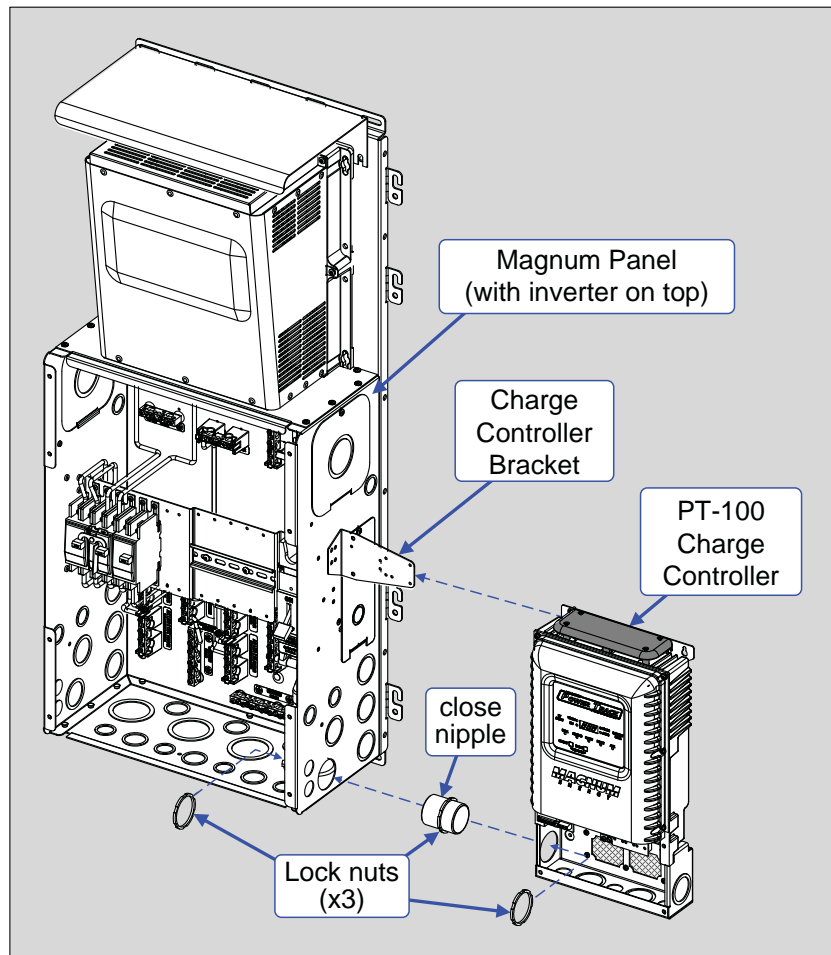

Figure 2-8, Mounting the PT-100 Controller on a Magnum Panel

2.3.6.1.1 Installing the Charge Controller Bracket on a Magnum Panel

When a MP or MMP panel is used to mount the PT controller, a bracket is provided to allow the PT controller to be mounted to the side of the panel. This bracket can be easily mounted on either the left or right side of the enclosure. Refer to Figure 2-9 to locate the holes you will use to attach the PT controller to the bracket. Before mounting the bracket, use one of the provided T20 Torx drive, thread forming screws to pre-thread the appropriate hole - shown as the "I" hole if mounted on the left side or the "H" hole if mounted on the right side.

After pre-threading the correct hole, locate the enclosure mounting holes used to attach the bracket to the enclosure. Before you mount the charge controller to the attached bracket, remove the appropriate knockout from the side of the controller and an adjacent knockout on the side of the enclosure. This allows you to use a close nipple with three locknuts to secure the charge controller to the enclosure (in addition to the bracket), and provides a path to run the necessary wiring between the two units. Mount the controller to the attached bracket using the two T15 Torx drive, flat head screws. Insert the close nipple through the knockouts and secure with the locknuts.

Info: The necessary hardware is provided to secure the bracket to a MP/MMP panel and to mount a PT charge controller to the bracket.

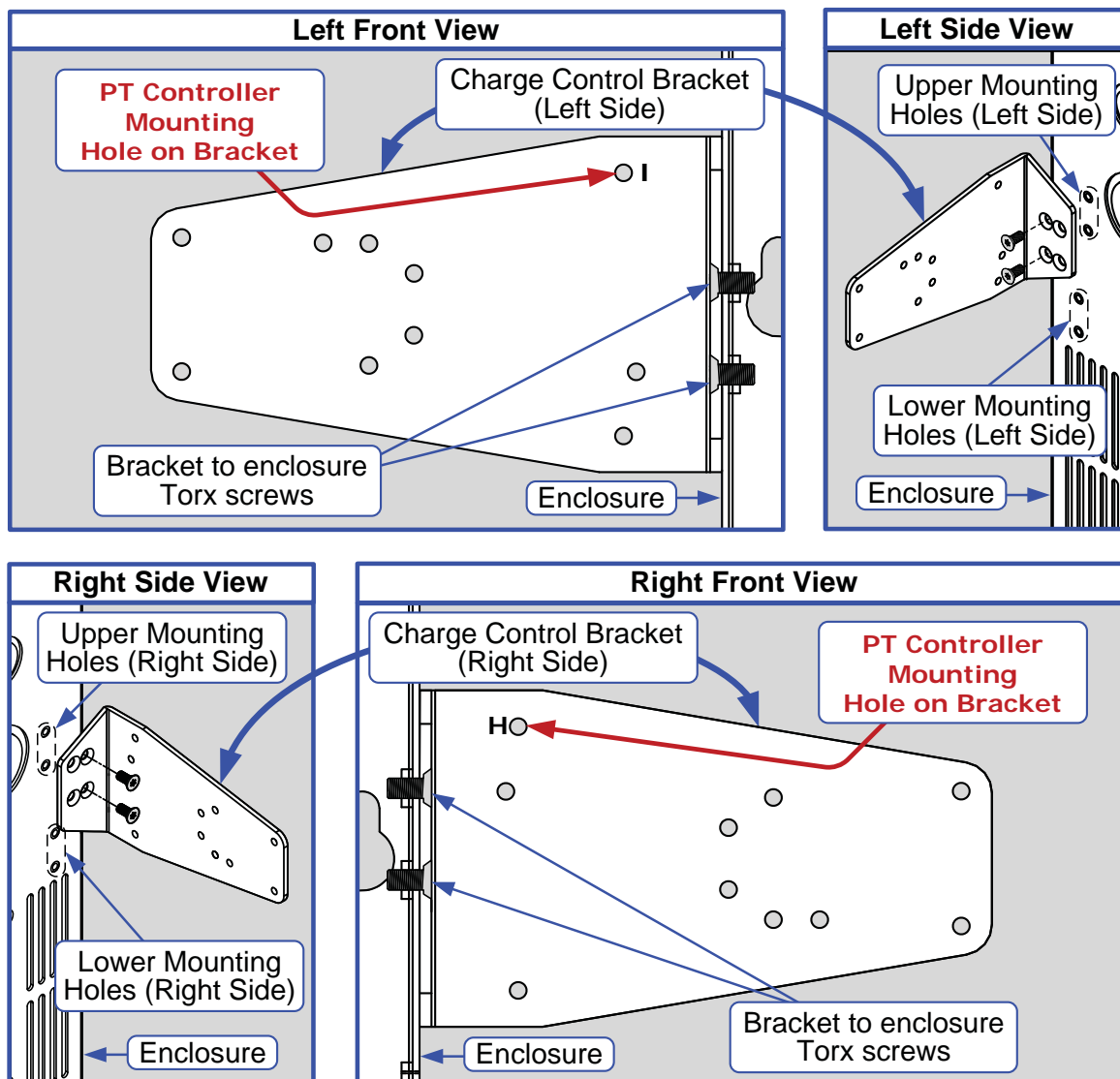

Figure 2-9, Holes Used to Mount Bracket on MMP Enclosure

2.3.6.2 Mounting the Charge Controller on a Vertical Surface

The PT controller is shipped with a bracket that consists of two identical plastic pieces. When these two pieces are connected together, they provide a complete wall-mounting bracket that allows the PT-100 to be mounted to a vertical surface (wall)—providing the required minimum 1" (2.5 mm) airflow clearance behind the controller. Refer to Figure 2-13 for bracket dimensions.



Info: The hardware to mount the PT controller to the bracket is provided. The hardware to secure the wall-mounting bracket to the wall is **not** supplied. It is recommended to use #8 sized (M5) fasteners. However, because mounting surfaces can vary, installers must determine the appropriate hardware for the installation. The surface and mounting hardware must be capable of supporting at least twice the weight of the charge controller (12.5 lb/5.7 kg), as well as the associated wiring/conduit.

2.3.6.2.1 Installing the Wall-mounting Bracket

After determining the proper mounting location, use the following steps to mount the PT controller on a wall or a similar flat upright surface with the two-piece mounting bracket (refer to Figure 2-12 to ensure a secure mounting).

To secure the wall-mounting bracket to a vertical surface:

1. Use one of the bracket pieces for the bottom half of the bracket and hold it on the mounting surface at the desired height. While using a level to ensure it is horizontally and vertically straight (and the openings in the bracket are faced toward the top), insert two #8 sized screws into any of the wall mounting holes (designated as "W" in Figure 2-10).
2. Now that the bottom bracket is mounted, use the other bracket piece as the top half and insert it into the openings of the bottom bracket. While holding the top bracket in place, insert two #8 sized screws into any of the designated "W" wall mounting holes (see Figure 2-10).
3. Insert screws into the remaining wall mounting holes ("W") and ensure the bottom and top bracket pieces are firmly attached to the mounting surface.

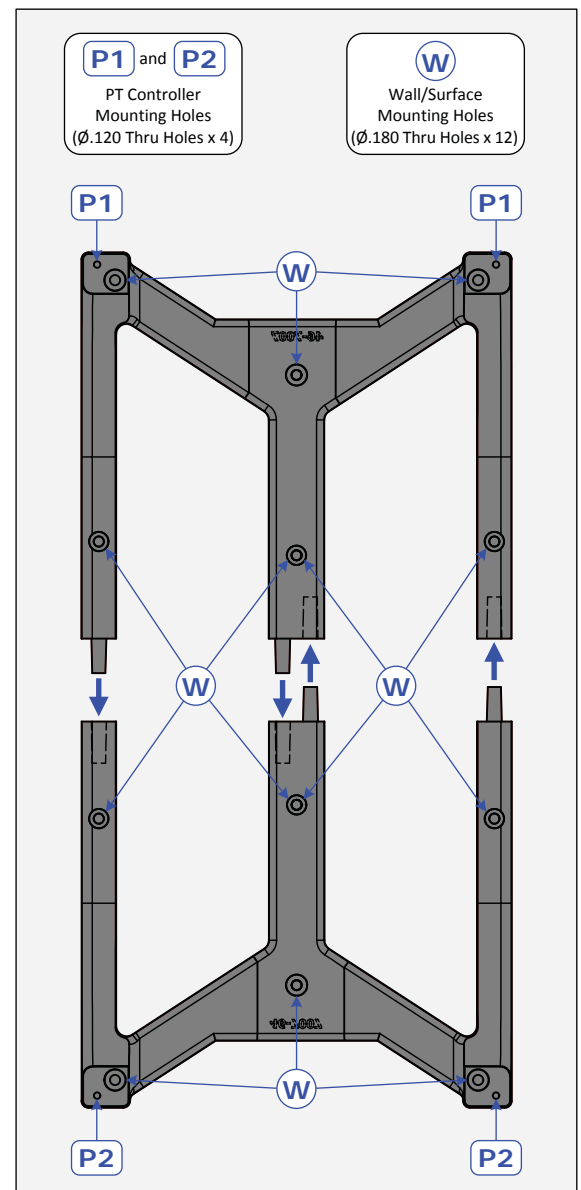

Figure 2-10, Mounting Bracket Thru-hole Callouts

2.3.6.2.2 Mounting the Charge Controller on the Wall-mounting Bracket

Once the wall-mounting bracket is securely fastened to the vertical surface, you can now attach the PT charge controller. Refer to Figures 2-11 and 2-12.

To mount the charge controller to the wall-mounting bracket:

1. Using two of the #8 Phillips head screws provided, insert the screws into the top two mounting holes of the wall-mounting bracket (designated as "P1" in Figure 2-10). Tighten these screws until there is a ¼" (6.4 mm) gap between the bracket's mounting hole surface and the screw head.
2. Hang the PT controller onto the wall-mounting bracket by placing the two keyhole openings of the PT controller (designated as "P1" in Figure 2-11) onto the two #8 screws—ensuring the controller is securely held in place before releasing.
3. Align the two mounting holes in the bottom of the PT controller (designated as "P2" in Figure 2-11) over the two bottom mounting holes on the bracket (designated as "P2" in Figure 2-10).
4. While holding the controller over these bottom mounting holes, insert the other two #8 Phillips screws provided.
5. Secure the PT controller to the mounting surface by tightening all four of the Phillips screws, and then verify that the controller is firmly attached to the mounting bracket.

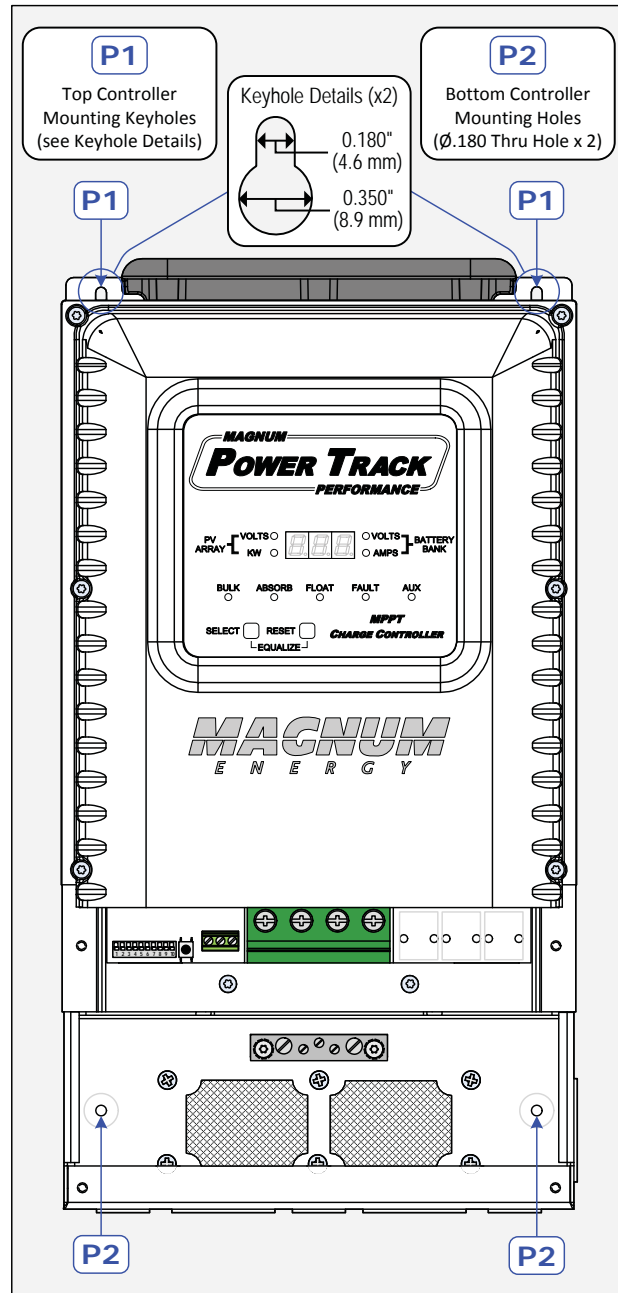

Figure 2-11, PT Controller Mounting Holes

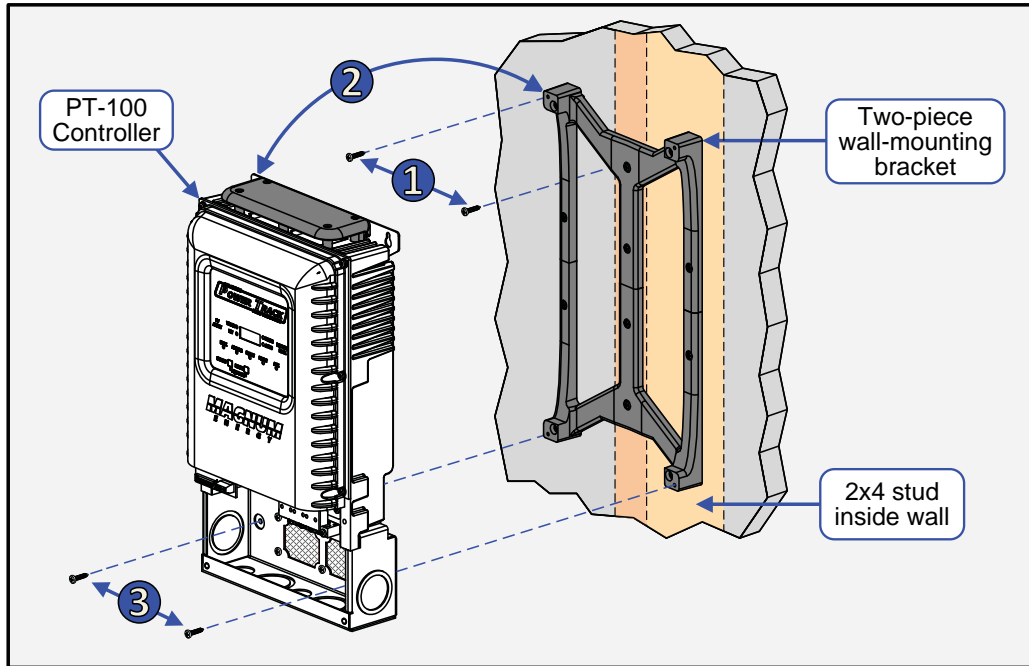

Figure 2-12, Surface-mounting the PT-100 Controller

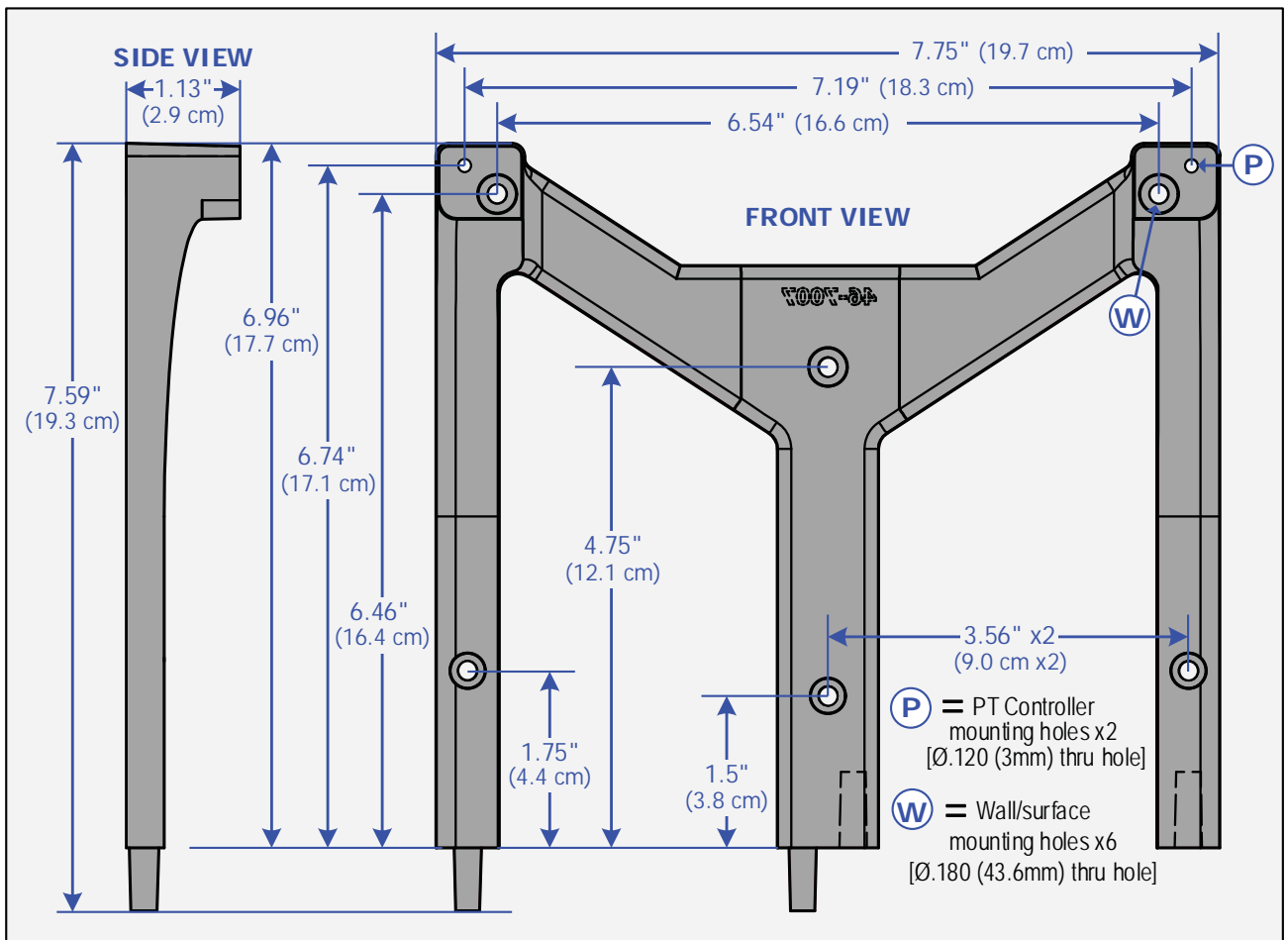

Figure 2-13, Mounting Bracket Dimensions (Each)

2.4 Electrical System Wiring Diagrams

A diagram of the PV and battery wiring for the PT-100 controller is shown in Figure 2-14 and is provided to assist you or your system installer. Due to the variety of applications and differences in local and national electrical codes, this wiring diagram should only be used as a general guideline. It is not intended to override or restrict any national or local electrical codes; and, this diagram should not be the determining factor as to whether the installation is compliant, that is the responsibility of the electrician and the onsite inspector.



Info: The MP and MMP Series panels have been specifically designed to conveniently connect a Magnum inverter and the PT-100 charge controller. The panels allow the PT-100's required PV and battery DC disconnects and all common wire connection points to be connected together, accessible from the front and marked in an easy to install pre-wired enclosure.

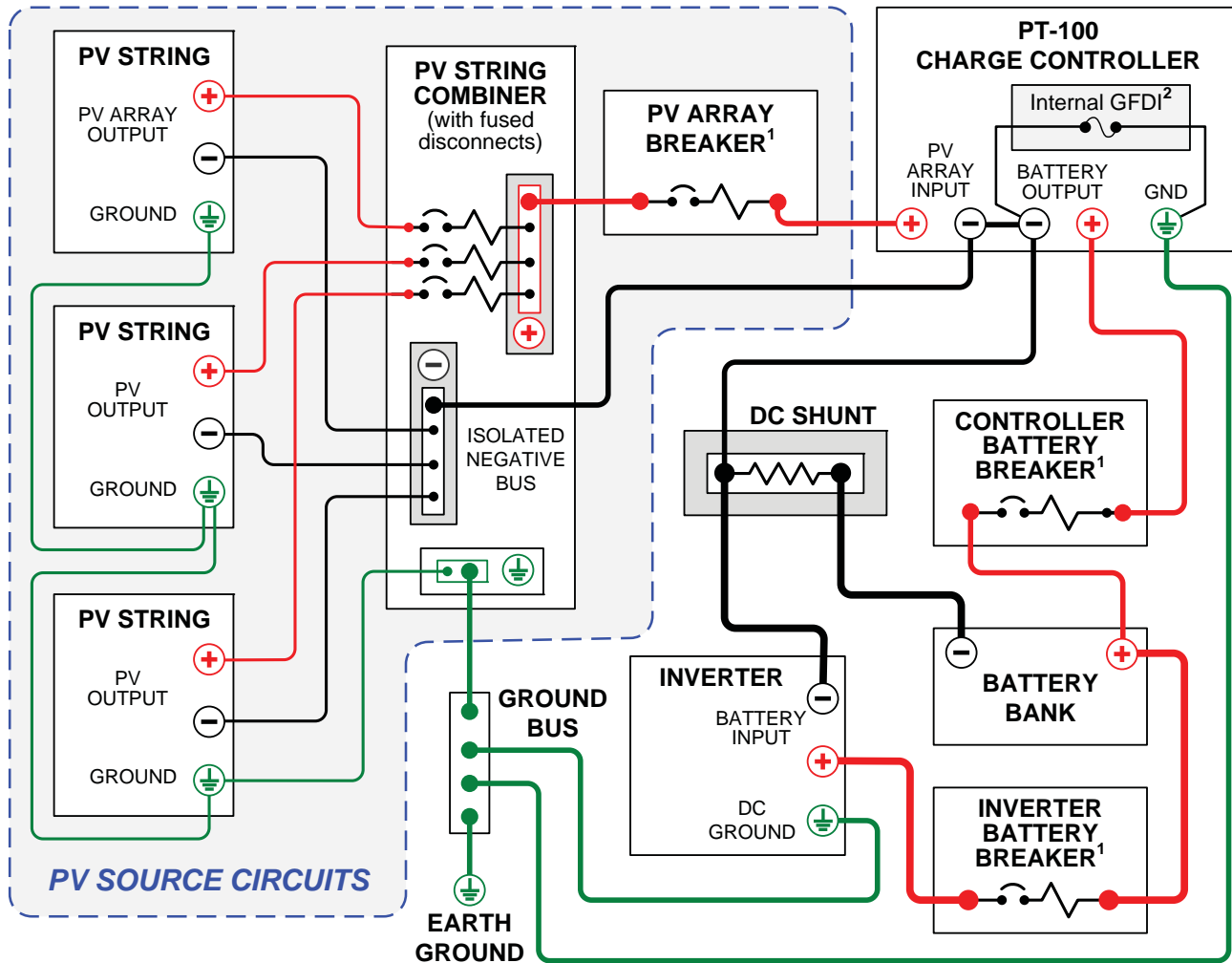

Note 1: Breaker provides disconnect and overcurrent protection.

Note 2 The battery negative-to-ground connection is only made inside the PT-100 controller. If another battery negative-to-ground connection is made, then the GFDI (Ground Fault Detection/Interruption) fault will activate.

Figure 2-14, PT-100 Controller - System Wiring

2.5 PV Voltage Requirements

Proper array sizing is crucial to ensure the maximum power output of the PV array is within the PT controller’s MPPT voltage range during normal operating conditions, and to ensure the PV voltage does not exceed the PT-100’s maximum input voltage limit—to prevent damage to the PT-100. Changes in environmental conditions, such as solar irradiance and ambient temperature, affect the PV array’s voltage and current output, and need to be considered when sizing and wiring the array to work with the PT-100 controller.

A PV module’s output voltage is mainly affected by temperature (and to a lesser degree by solar irradiation). When temperatures are cold, the module’s voltage increases; as the module’s temperature increases, the voltage level decreases. The panel manufacturer usually lists a negative temperature coefficient rating that provides the amount of voltage change, some are listed in negative mV per degree Celsius (-mV/°C) and others are listed as a negative percentage per degree Celsius (-%/°C). These negative temperature coefficients mean that for every 1°C change in temperature, the module’s voltage rating will change in the opposite direction.

The panel manufacturer provides a V_{OC} and V_{MP} rating per panel, but they are normally rated at 25°C. The voltage change coefficient for the V_{OC} and V_{MP} are different. They both need to be calculated to ensure they meet the requirements of the controller and to determine how many PV modules to connect in series.



Info: Excellent resources for local weather information can be found at: www.weather.com and www.weatherbase.com.



Info: The negative sign in front of the temperature coefficient rating indicates a negative correlation coefficient, meaning the two variables are in an inverse relationship. For PV modules, as the temperature goes down, the module voltage increases.

2.5.1 PV Input Voltage Limits for the PT-100

The following PV voltage levels are required for the PT-100 controller to operate:

- **PV Array’s Maximum Output Voltage (V_{OC-MAX})** - The PV array should be designed to ensure the Open Circuit Voltage (V_{OC}) of the PV array string - at the lowest expected ambient temperature—should never exceed the maximum PV input voltage level of the PT-100 to avoid damaging the controller.
- **PV Array’s Upper Output Voltage (V_{OC-UPP})** - The PV array should be designed to ensure the Open Circuit Voltage (V_{OC}) of the PV array string - at the lowest average ambient temperature—does not normally operate above the upper level of the MMPT voltage range of the PT-100 to prevent the PT-100 from unnecessarily shutting down.
- **PV Array’s Lower Maximum Power Voltage (V_{MP-LOW})** - The PV array should be designed to ensure the Maximum Power Voltage (V_{MP}) of the PV array string—at the highest average ambient temperature—does not normally operate below the lower level of the MMPT voltage range to deliver the optimal energy to the batteries.

Table 2-1, PV Input Voltage Parameters

Nominal Battery Bank Voltage	MPPT Voltage Range		High V_{OC} Range	Max PV Input Voltage Level
	Lower V_{MP} Level	Upper V_{MP} Level		
12V	24 VDC	187 VDC	188 - 210 VDC	≥211 VDC
24V	41 VDC	187 VDC	188 - 220 VDC	≥221 VDC
48V	73 VDC	187 VDC	188 - 240 VDC	≥241 VDC



CAUTION: Ensure the array’s V_{OC} is kept below the Max PV Input Voltage level under any condition. Voltage above this level has a high probability of causing damage to the PT-100.

2.5.2 Determining the Maximum PV Array Voltage

In order to size the PV array so that the output voltage never exceeds the maximum PV input voltage limit on the PT-100, the maximum number of modules in series need to be determined. To do this, you must first determine—from the installation location—the V_{OC} of the individual module at the lowest expected temperature.



CAUTION: PV array voltage that exceeds the maximum PV input voltage rating can damage components in the PT-100 and is not covered under warranty. When sizing the array, the NEC says to use the “lowest expected ambient temperature”. It is highly recommended that you find the historical record low temperature for your location and use this value for the “lowest expected ambient temperature” calculations. This is a conservative approach, but is justified to prevent high voltage damage to the PT-100. Be aware that the maximum PV voltage level is recorded in the PT-100’s internal memory, allowing this voltage to be checked if repair is required.



Info: If the PV module manufacturer does not provide a temperature coefficient rating, Table 690.7 in the NEC can be used if it is a crystalline module. This table gives a correction factor that can be applied to determine the temperature compensated voltage.

- **1A) Calculating Module’s Maximum Output Voltage (V_{OC-MAX}):**

To calculate the module’s maximum output voltage based on the module manufacturer’s temperature coefficient method—at the lowest recorded local temperature, use one of the formulas below:

a) If coefficient in percentage (%) use: $V_{OC-MAX} = V_{OC} \times \{1 + [(T_{LOW} - T_{STC}) \times \alpha V_{OC}(\%)]\}$

b) If coefficient in voltage (V) use: $V_{OC-MAX} = V_{OC} + [(T_{LOW} - T_{STC}) \times \alpha V_{OC}(V)]$

- V_{OC-MAX} = module’s maximum output voltage
- V_{OC} = module’s rated open circuit voltage at STC (25°C)
- T_{LOW} = module’s temperature at the lowest recorded local temperature
- T_{STC} = module’s temperature at STC (25°C)
- $\alpha V_{OC}(\%)$ = temperature coefficient of V_{OC} provided as %
- $\alpha V_{OC}(V)$ = temperature coefficient of V_{OC} provided as V

- **1B) Calculating Absolute Maximum Number of Modules in Series:**

After calculating the module’s maximum output voltage (V_{OC-MAX}), determine the maximum number of modules that can be placed in series. Refer to Table 2-1 to find the maximum PV input voltage based on the battery bank connected to the PT-100.

Once the maximum PV input voltage has been determined, divide this value by V_{OC-MAX} and then round down to the nearest whole number. This whole number value is the absolute maximum number of modules that can be placed in a series string to ensure the Open Circuit Voltage (V_{OC}) of the PV array does not exceed the maximum PV input voltage level of the PT-100.

Examples - Determining the array's maximum voltage:

Using the correct formula (based on which module's temperature coefficient method is provided) and the values in our scenarios below, first determine the module's maximum output voltage (V_{OC-MAX}), and then use this value to figure the maximum number of modules that can be connected in series.

Find the maximum number of PV modules in series to use with the PT-100 (with αV_{OC} coefficient provided in percentage):

Scenario: The module has an open circuit voltage rating of $37.4V_{OC}$ at STC ($25^{\circ}C$), and the V_{OC} temperature coefficient is $-0.351\%/^{\circ}C$. The modules are going to be installed in an area where the temperature has dropped to a record low of $-18^{\circ}C$. The controller is connected to a 48-volt nominal battery bank where the highest charging voltage required will be 66 volts.

1. What is the module's maximum voltage (V_{OC-MAX})? 43.0V (as calculated below)

$$\begin{aligned} V_{OC-MAX} &= V_{OC} \times \{1 + [(T_{LOW} - T_{STC}) \times \alpha V_{OC}(\%)]\} \\ V_{OC-MAX} &= 37.4V \times \{1 + [(-18^{\circ}C - 25^{\circ}C) \times -.351\%/^{\circ}C]\} \\ V_{OC-MAX} &= 37.4V \times \{1 + [-43^{\circ}C \times -.351\%/^{\circ}C]\} \\ V_{OC-MAX} &= 37.4V \times \{1 + [-43^{\circ}C \times -.00351/^{\circ}C]\} \\ V_{OC-MAX} &= 37.4V \times \{1 + .1509\} \\ V_{OC-MAX} &= 37.4V \times \{1.1509\} = 43.04 \\ V_{OC-MAX} &= \mathbf{43.0V} \end{aligned}$$

2. What is the PT-100's maximum PV input voltage (see Table 2.1)? 240V (48-volt system)

3. What is the maximum number of modules that may be installed in series? $240V \div 43V = 5.58 = 5$ modules (rounded down to the next whole number).

*Answer: You should connect no more than **5** of these modules in series to ensure the array's voltage stays below the PT-100's maximum PV input voltage level.*

Find the maximum number of PV modules in series to use with the PT-100 (with αV_{OC} coefficient provided in voltage):

Scenario: The module has an open circuit voltage rating of $37.8V_{OC}$ at STC and the V_{OC} temperature coefficient is $-.113V/^{\circ}C$. The modules are going to be installed in an area where the temperature has dropped to a record low of $-18^{\circ}C$. The controller is connected to a 48-volt nominal battery bank where the highest charging voltage required will be 66 volts.

1. What is the module's maximum voltage (V_{OC-MAX})? 42.7V (as calculated below)

$$\begin{aligned} V_{OC-MAX} &= V_{OC} + [(T_{LOW} - T_{STC}) \times \alpha V_{OC}(V)] \\ V_{OC-MAX} &= 37.8V + [(-18^{\circ}C - 25^{\circ}C) \times -.113V/^{\circ}C] \\ V_{OC-MAX} &= 37.8V + [-43^{\circ}C \times -.113V/^{\circ}C] \\ V_{OC-MAX} &= 37.8V + [4.859] = 42.66 \\ V_{OC-MAX} &= \mathbf{42.7V} \end{aligned}$$

2. What is the PT-100's maximum PV input voltage (see Table 2.1)? 240V (48-volt system)

3. What is the maximum number of modules that may be installed in series? $240V \div 42.7V = 5.62 = 5$ modules (rounded down to the next whole number).

*Answer: You should connect no more than **5** of these modules in series to ensure the array's voltage stays below the PT-100's maximum PV input voltage level.*

2.5.3 Determining the Upper Output Voltage (V_{OC-UPP})

This section details how to determine the maximum number of modules allowed to be connected in that stays below the High V_{OC} range of the PT-100. The Open Circuit Voltage (V_{OC}) of the PV array should normally operate below the High V_{OC} range of the PT-100, (which is also the upper limit of the MMPT voltage range). The PT-100 will shutdown if the voltage is allowed to rise into the High V_{OC} range. While this is not as critical as exceeding the maximum V_{OC} limit—which can damage the PT-100—the energy from the array cannot be used because the PT-100 is not operating.

Because the PV module voltage increases at low temperatures, use the following calculation to determine the V_{OC} of the individual module at the lowest average temperature at the installation location. Once the module's upper V_{OC} level is calculated, you can determine the maximum number of modules allowed to be connected in series that will stay below the Upper V_{OC} limit of the PT-100.

- **2A) Calculating Module's Maximum Voltage (V_{OC-UPP}):**

To calculate the module's upper output voltage (V_{OC-UPP}) level, use the formula below:

$$V_{OC-UPP} = V_{OC} + [(T_{AVG-L} - T_{STC}) \times \alpha V_{OC}(V)]$$

- V_{OC-UPP} = module's upper output voltage
- V_{OC} = module's rated open circuit voltage at STC (25°C)
- T_{AVG-L} = module's temperature at the lowest average temperature
- T_{STC} = module's temperature at STC (25°C)
- $\alpha V_{OC}(V)$ = temperature coefficient of V_{OC} provided as V



Info: When lower than average temperatures occur, the module's V_{OC} may rise above the PT-100's upper MPPT voltage limit. This is not of great concern because this is likely to occur when irradiance is very low (i.e., a few hours before sunrise). If sized correctly, once the sun rises and the temperature starts increasing, the array's V_{OC} should fall within the MMPT voltage range and begin operating.

- **2B) Calculating Maximum Number of Modules in Series for Upper V_{OC} :**

After calculating the module's upper V_{OC-UPP} level, determine the maximum number of modules that can be placed in series and still remain below the High V_{OC} range (or below the upper V_{MP} level) when operating in normal/average temperature conditions. Refer to Table 2-1 to find the upper MPPT voltage limit based on the particular battery bank connected to the PT-100.

Once the controller's upper MPPT voltage limit has been determined, divide this value by the V_{OC-UPP} calculation and then round down to the nearest whole number. This whole number value is the maximum number of modules that should be placed in a series string to ensure the PV array's V_{OC} remains below the High V_{OC} range of the PT-100.

2.5.4 Determining the Lower Maximum Power Voltage (V_{MP-LOW})

Lastly, you must ensure the maximum power voltage (V_{MP}) of the individual module at the lowest expected temperature does not fall below the controller's lower MPPT voltage limit. When determining the number of modules in series, the V_{MP} of the modules connected in series should normally operate within the MMPT voltage range of the PT-100; thereby, maximizing the energy output of the PV system. This section details how to calculate the V_{MP} of the individual module at the lowest expected temperature, and how to use this value to determine the minimum number of modules allowed to be connected in series that will stay above the lower MMPT voltage limit of the PT-100.

- **3A) Calculating Module's Lower V_{MP} Level**

Because PV modules have a reduction in voltage at high temperatures, make sure the V_{MP} of the modules connected in series do not fall below the controller's lower MPPT voltage limit. Otherwise the PT-100 will adjust to its lower MPPT voltage limit—resulting in power loss. To do this, the V_{MP} of the individual module at the lowest expected temperature (at the installation location) must first be determined.



Info: The module's lower V_{MP} level (V_{MP-LOW}) is directly dependant on the module's highest temperature and the particular method used to mount the PV array.

To calculate the module's lower V_{MP} (V_{MP-LOW}) level, use the formula below:

$$V_{MP-LOW} = \{V_{MP} \times [(T_{AVG-H} + T_{Rise} - T_{STC}) \times \alpha V_{MP}(V)]\} \times 0.80^1$$

- V_{MP-LOW} = module's lower V_{MP} level
- V_{MP} = module's voltage at maximum power output
- T_{AVG-H} = module's temperature at the highest average temperature²
- T_{Rise} = temperature rise applied based on PV module's mounting method
 - a) Parallel to roof (<6" inches of clearance behind them): +35°C
 - b) Rack-type mount (>6" inches of clearance behind them): +30°C
 - c) Pole mount or free standing (plenty of air circulation around them): +25°C
- T_{STC} = module's temperature at STC (25°C)
- $\alpha V_{MP}(V)$ = temperature coefficient of V_{MP} provided as voltage



Info: Different PV mounting methods cause the module temperature to rise and the modules to operate at lower maximum power point voltage levels. There are three typical PV array mounting methods: 1) Parallel to Roof - the modules are flat against the roof, have less than 6" inches of clearance behind them, or have no air circulation on the back side, and have about a 35°C temperature rise. 2) Rack-type mount - the modules have at least 6" behind the panel and the roof, or are mounted at an angle so air can circulate behind, and have about a 30°C temperature rise. 3) Pole mount or a freestanding frame - the modules are above the ground with plenty of air circulation, and have a temperature rise of about 25°C.



Info: If the V_{MP} temperature coefficient is listed as percentage instead of voltage, you can convert %/°C to V/°C by multiplying the V_{MP} by the percentage temperature coefficient. For example: If the V_{MP} is 29.5V and the V_{MP} temperature coefficient is -0.45%/°C, then the V temp coefficient is: 29.5V x -0.45%/°C = -0.133V/°C.

Note 1: 0.80 derating multiplier. A derating multiplier that takes into consideration several factors for low voltage issues is applied. Derating factors include the voltage drop of the cables from the PV array to the controller, operating at low irradiance levels less than STC (1kW/m²), and degradation and high voltage tolerances of the module. Taking all these factors into account, a 20% derating multiplier (0.80) is applied.

Note 2: When determining the highest average temperature value for your location, many resources can be used. You can use the Average High Temperature (highest month) at www.weatherbase.com and at www.weather.com. Additionally, you can use the 2% Annual Design Dry Bulb Temperature found in the ASHRAE Handbook – Fundamentals which can be found using the interactive Solar Reference Map at: www.solarabcs.org/permitting/map, shown on the map as High Temp. (2% Avg.).

3B) Calculating Minimum Number of Modules in Series for Lower V_{MP} :

After calculating the module’s lower V_{MP-LOW} level, determine the minimum number of modules that can be placed in series. Refer to Table 2-1 to find the PT-100’s lower MPPT voltage limit based on the particular battery bank connected to the PT-100.

Once the controller’s lower MPPT voltage limit has been determined, divide this value by the V_{MP-LOW} calculation and round up to the nearest whole number. This whole number value is the minimum number of modules that can be placed in a series string to ensure the PV array’s V_{MP} remains above the PT-100’s lower V_{MP} level.

Examples - Determining the array’s upper and lower voltage levels.

Using the values in the scenario below, determine the module’s upper V_{OC} level (V_{OC-UPP}) level, and then the lower V_{MP} level (V_{MP-LOW}). Use these values to determine the minimum and maximum number of modules that should be connected in series.

Scenario: A module has a maximum power voltage rating of 31.4V_{MP} at STC (25°C) and the V_{MP} temperature coefficient is $-.141V/°C$. The modules are going to be installed in an area where the temperature rises to an annual average high of 24°C and falls to an average low of 1°C. The array will be mounted flat on the roof with minimum clearance (+35°C). The controller is connected to a 48-volt nominal battery bank where the highest charging voltage required will be 66 volts.

A. Find the maximum number of PV modules that can be connected in series that will stay below the upper V_{OC} level.

1. What is the module’s upper V_{OC} level (V_{OC-UPP})? 34.8V (as calculated below)

$$\begin{aligned} V_{OC-UPP} &= V_{OC} + [(T_{AVG-L} - T_{STC}) \times \alpha V_{OC}(V)] \\ V_{OC-UPP} &= 31.4V + [(1°C - 25°C) \times -.141V/°C] \\ V_{OC-UPP} &= 31.4V + [(-24°C) \times -.141V/°C] \\ V_{OC-UPP} &= 31.4V + [3.38] = 34.78 \\ V_{OC-UPP} &= \mathbf{34.8} \end{aligned}$$

2. What is the PT-100’s upper MPPT Voltage level (see Table 2.1)? 187V (48-volt system)

3. What is the maximum number of modules that may be installed in series? $187V \div 34.8V = 5.37 = 5$ modules (rounded down to the next whole number).

Answer: You should connect no more than **5** of these modules in each series string to remain below the PT-100’s upper V_{MP} level.

B. Find the minimum number of PV modules that can be connected in series that will stay above the lower V_{MP} level.

1. What is the module’s lower V_{MP} level (V_{MP-LOW})? 21.3V (as calculated below)

$$\begin{aligned} V_{MP-LOW} &= \langle V_{MP} + [(T_{AVG-H} + T_{Rise} - T_{STC}) \times \alpha V_{MP}(V)] \rangle \times 0.80 \\ V_{MP-LOW} &= \langle 31.4V + [(24°C + 35°C - 25°C) \times -.141V/°C] \rangle \times 0.80 \\ V_{MP-LOW} &= \langle 31.4V + [(34°C) \times -.141V/°C] \rangle \times 0.80 \\ V_{MP-LOW} &= \langle 31.4V + [-4.79] \rangle \times 0.80 \\ V_{MP-LOW} &= \langle 26.61 \rangle \times 0.80 = 21.29 \\ V_{MP-LOW} &= \mathbf{21.3V} \end{aligned}$$

2. What is the PT-100’s lower MPPT Voltage level (see Table 2.1)? 73V (48-volt system)

3. What is the minimum number of modules that may be installed in series? $73V \div 21.3V = 3.43 = 4$ modules (rounded up to the next whole number).

Answer: You should connect at least **4** of these modules in each series string to remain above the PT-100’s lower V_{MP} level.

2.6 Conductor Sizing for the PV System

It is important to use the correct sized DC wire (or conductor) in a Standalone PV System (includes PV, controller and standalone inverter) to achieve maximum system efficiency and to reduce fire hazards associated with overheating. The NEC (Section 690) provides the requirements for proper conductor sizing and current calculations for PV systems. This section will help you to correctly size the conductors in your PV system by following a set of calculations in sequence.

You must determine the maximum current for each PV circuit, then select a conductor that will handle this maximum current (under all conditions), and finally, select an overcurrent protection device that correctly protects the conductor.

2.6.1 Determining Maximum Circuit Currents (I_{MAX})

The NEC defines how to calculate the maximum circuit current values in a Standalone PV System. To calculate and apply the maximum current values, determine the specific circuit you are dealing with from the list below. Figure 2-15 is provided to help illustrate the specific current circuits.

①	PV Source Circuits - conductors between modules and from the modules to the DC system's common connection point (i.e., String Combiner). The maximum current for each series-string source circuit is the module's rated short circuit current (I_{SC}) x 125% ($I_{MAX} = I_{SC} \times 1.25$).
②	PV Output Circuit - conductors between the photovoltaic source circuit(s) and the DC utilization equipment (i.e., Charge Controller). The maximum current for this circuit is the sum of the PV source circuit maximum currents in parallel ($I_{MAX} = I_{SC} \times 1.25 \times \text{parallel strings}$).
③	PT-100 Output Circuit - conductors between the PT-100 and the battery. The maximum current for this circuit is the controller's maximum output current rating ($I_{MAX} = 100ADC$). <i>Note: NEC 690.8(A)(5), defines the maximum output current for DC-to-DC converters. The PT-100 is applicable to this requirement as it is an electronic DC-to-DC converter.</i>
④	Standalone Inverter DC Input Circuit - conductors between the inverter and the battery. The maximum current for this circuit is the standalone continuous inverter input current rating when the inverter is producing rated power at the lowest input voltage.
⑤	Inverter AC Output Circuit - conductors that run from the AC output terminals of the inverter to the inverter's AC electrical panel. The maximum current for this circuit is the inverter's continuous output current rating.

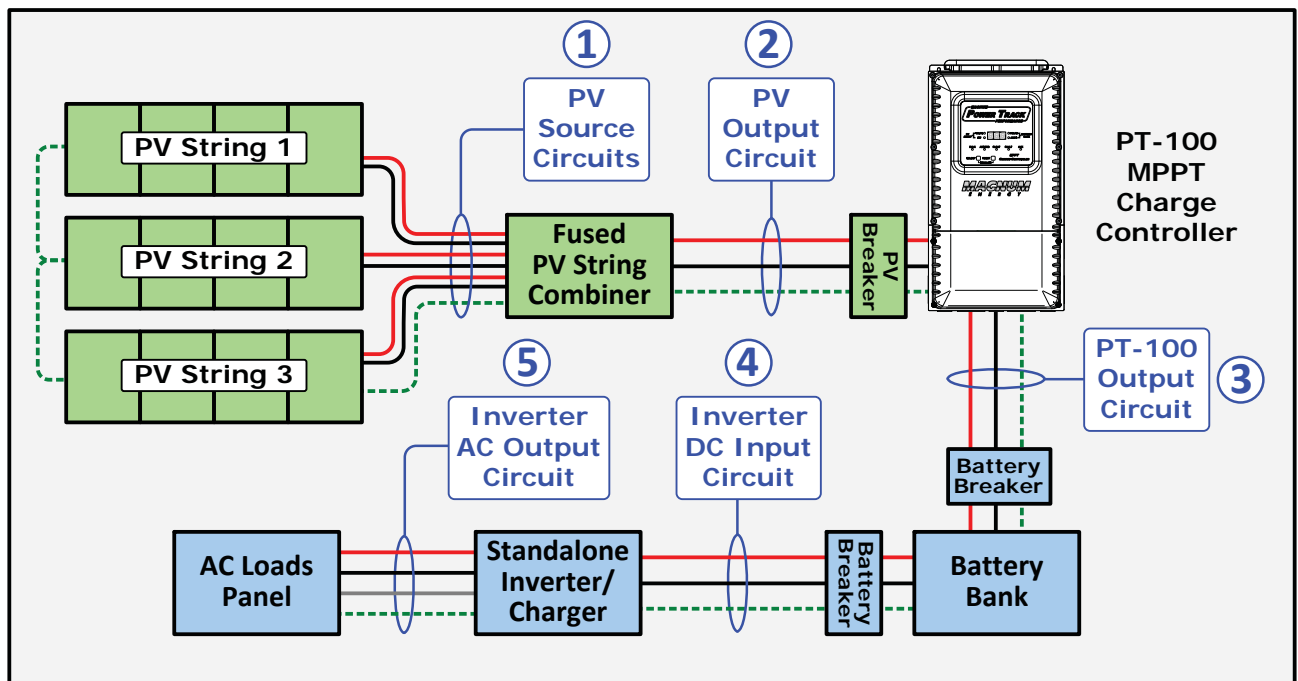

Figure 2-15, Standalone PV System Circuits

2.6.2 Select the Correct Conductor

To properly determine the required ampacity of the conductors in the PV System circuits, the NEC requires a comparison of conductors that are sized with different adjustment factors. A conductor sized to continuously carry the maximum current is calculated and compared against a conductor sized with conditions-of-use factors applied. The conductor size with the greatest ampacity—after it is associated with the lowest temperature rating of any terminal in the circuit—between the two is selected.

- **Continuous Current Calculation** - The first calculation takes into consideration that the maximum current in PV circuits is considered to be continuous, which is defined as circuits being able to deliver current for more than three hours. Therefore, the maximum continuous current of these circuits is multiplied by 125% to ensure the conductors do not carry more than 80% of their rated value ($I_{\text{CONT}} = I_{\text{MAX}} \times 1.25$).



Info: For PV source circuits and the PV output circuit, the first required 1.25 multiplier is to account for sustained periods when the sun's intensity (irradiance) can cause module current outputs to be greater than their rated STC irradiance value. The second 1.25 multiplier is related to the NEC requirement to keep conductors from normally operating above 80 percent ($1 \div 0.80 = 1.25$). These two multipliers taken together is referred to as the 156% rule, because $1.25 \times 1.25 = 1.56$.

- **Conditions-of-Use Calculation** - The second calculation adjusts for worst-case installation conditions. It requires adjustment and correction factors (commonly referred to as conditions-of-use) to be applied to the maximum circuit currents. Conditions-of-use factors take into account the number of current carrying conductors that are close to each other when run in conduit (i.e., conduit fill), and the temperature to which the conductors are exposed.



Info: The condition-of-use calculation is required because large adjustments due to multiple current-carrying conductors and high-temperature operation can result in reduced ampacity, which often results in a conductor that is larger than the conductor sized for continuous current.

- **Conduit Fill Correction** - Conduit fill refers to the number of current-carrying wires of a particular size and type allowed in a particular size of conduit. Adjustments to the conductor ampacity is required if there are more than three current carrying conductors in conduit or bundled together (excludes grounding conductors) in continuous lengths greater than 24 inches. Use the conduit fill adjustment factor in Table 2-5 after determining how many current carrying conductors in a conduit/raceway run greater than 24 inches.
- **Temperature Correction** - As is common in PV systems, conductors can operate at extreme temperatures, which can reduce the conductor's overall ampacity. If the wire is subjected to ambient temperature conditions greater than 30°C or exposed to sunlight on or above rooftops, the size of the conductors will need to increase to compensate for lost ampacity. For temperature correction calculations, first determine the local ambient temperature¹. If the average high temperature is greater than 30°C, then an ambient temperature factor is required to be applied to the ambient temperature (see Table 2-3). Also, if the conductors or raceways are exposed to sunlight on a roof, code requires an additional rooftop temperature value (or adder) that must be added to the average high ambient temperature based on the height of the conductor/raceway from the roof surface (see Table 2-4).

Note: If you use the Solar ABC's website for high temperature data, the rooftop temperature adder is already factored in the *Distance above roof* calculations.

Note 1: Many PV designers use the 2% average high temperature data from the ASHRAE Handbook - Fundamentals to find local ambient temperatures. This data is readily available using the interactive map at the Solar ABCs website (<http://solarabcs.org/about/publications/reports/expedited-permit/map/index.html>). While the high temperature data is recommended for conductor ampacity sizing, more conservative cold temperature data is recommended when sizing for array voltage (which can damage the PT-100 controller). See the caution note in Section 2.5.2 for more information.

Check the Terminal Temperature Rating - Whether the conductor is sized to continuously carry the maximum current or sized with conditions-of-use factors applied, the temperature rating associated with the ampacity of a conductor must be coordinated so as not to exceed the lowest temperature rating of any terminal, device, or conductor of the circuit.

Regardless of the insulation temperature rating of the selected conductor, it must continue to provide the minimum ampacity required when rated at the temperature of the connected terminals. It is common in a PV system to use a conductor that is rated at 90°C while connecting to a device (e.g., fuse holder, circuit-breaker, etc.) that has terminals rated for only 75°C. When a conductor is connected to a device with terminals rated at a lower temperature than the temperature rating of the conductor's insulation, the conductor's ampacity is now based on the lower temperature rating. This ensures a minimum amount of copper is provided to pull enough heat away from the terminal to prevent overheating problems. Check the temperature ratings of all the terminals to which the conductor is connected and ensure the ampacity associated with the lower terminal temperature rating is equal to or greater than the minimum ampacity required.

Determine the minimum conductor size by finding the lowest terminal temperature rating of all the devices to which the conductor is connected. Use Table 2-2 to select the temperature column that is based on the terminal with the lowest temperature rating. Select the conductor size in the proper terminal temperature rating column that has an ampacity rating equal to or greater than the calculated continuous current (I_{CONT}).

For example, with a conductor connected to a 60°C termination on one end and a 75°C termination on the other, the conductor's ampacity must not exceed the rating listed in the 60°C column - because the lowest connection point is a 60°C rating.



Info: Even though conductors with a 90°C or 105°C insulation rating can't be applied at their higher ampacity ratings because the terminal temperature is lower, they do have an advantage. Their higher ampacity rating can be used when applying derating factors due to ambient conditions or when exceeding more than 3 current carrying conductors in conduit.



Info: Remember to consider both ends of the conductor when derating. For example, if one end of the conductor is connected to a circuit breaker with a 75°C terminal, and the other end is connected to a receptacle with a 60°C terminal. The conductor must have an insulation rating no less than the highest temperature rated terminal (75°C circuit breaker), and the ampacity of the conductor must be sized no smaller than the lowest temperature rated terminal (60°C receptacle). *Note: The ampacity sizing is to ensure no additional heat is created at the receptacle terminals by using wire that is too small.*



Info: The terminal temperature limits marked on the equipment must be used. If no temperatures are marked, then a 60°C limit is used for circuits rated at 100 amps or less or cables #14 to 1 AWG. For circuits rated greater than 100 amps and for conductors greater than 1 AWG, a 75°C terminal temperature limit is used.

Check the Voltage Drop - Excessive system voltage drops due to wire size, wire connections, and fuse/circuit breakers can limit the charge current and affect battery charging performance. If there is a long wire run between the PV array and the PT-100 controller, or between the PT-100 and the battery bank, larger wire should be used to reduce voltage drop and improve performance.

On the PV array to controller side, a derating multiplier is applied to take into account for low voltage issues when calculating the module's lower V_{MP} Level (see Section 2.5.4).

From the controller to the battery, voltage drop will lower the charge voltage at the battery. Table 2-8 provides increased wires sizes when the distance from the controller to the battery is longer than 5 feet.

The terminal block inside the PT controller is rated for a maximum 1 AWG. Wire sizes larger than 1 AWG (42.4mm²) that are used to reduce voltage drop cannot be installed directly into the terminal block. To use a larger size wire, use a splicer block or a split-bolt kerney external to the controller to allow the smaller wire size from the controller terminal block to be connected to the larger wire that is used and routed to the batteries.

2.6.3 Sizing the DC OverCurrent Protection Device (OCPD)

The final step necessary in sizing the DC conductor is to verify that the selected conductor can handle the current and is protected by the DC OverCurrent Protection Device (OCPD). Once you have identified the conductor that will handle the maximum continuous current (described in Section 2.6.2), ensure the continuous rating of the selected overcurrent protection device is not less than the maximum current for the circuit it is protecting and no greater than the ampacity of the conductor selected. Per code, the rating of the overcurrent protection device (OCPD) must comply with all of the following:



Info: Per the NEC: 690.9 (D) Photovoltaic Source and Output Circuits - Listed PV overcurrent devices shall be required to provide overcurrent protection in PV source and output circuits.

1. In a PV system which includes batteries, an OCPD is required for each PV source circuit.
To protect the internal connections of the module, the OCPD must not be sized larger than the maximum series current/fuse rating specified on the PV module's nameplate.
2. The OCPD must be sized to continuously carry the PV system's maximum currents (I_{MAX}).
Normally, OCPDs are only 80% continuous duty-rated; therefore, they must be multiplied by 125%¹ to handle PV circuit currents — which are considered continuous.
 - To determine the minimum OCPD size required to protect the conductor in the PV circuit, multiply I_{MAX} for a given PV system circuit by 1.25 (I_{MAX} for a given PV system circuit \times 1.25 = I_{CONT}).



Info: The 125% multiplier for the OCPD (for continuous operation) is on top of the 125% multiplier to the module's rated I_{SC} value (for high irradiance conditions) when sizing the PV source and PV output circuits for maximum circuit current.



Info: If no temperature rating is marked on the terminals, then a 60°C limit is used for circuits rated at 100 amps or less and for cables #14 to 1 AWG. For circuits rated greater than 100 amps and for conductors greater than 1 AWG, a 75°C terminal temperature limit is used.

3. When the OCPD is operated in environments where the temperature can reach 40°C (104°F) or higher, use the manufacturer's temperature correction factors to adjust the OCPD rating.



Info: The DC circuit breakers (PN: BR-75 to BR-125) have a terminal temperature limit of 75°C (for copper conductors) and a maximum operating temperature of 40°C.

4. Where the OCPD is rated at 800 amps or less, the following ratings are allowed:
 - a) You are allowed to use the next-higher standard OCPD above the ampacity of the conductors being protected.
Note: The PV module's maximum series fuse rating is not allowed to be exceeded. Standard ampere ratings are: 1, 3, 6, 10, 15, 20, 25, 30, 35, 40, 45, 50, 60, 70, 80, 90, 100, 110, 125, 150, 175, 200, 225, 250, 300, 350, 400, 450, 500, 600, 601, 700, 800, 1000, 1200, 1600, 2000, 2500, 3000, 4000, 5000, and 6000 amperes.
 - b) After any correction factors for ambient temperature and number of conductors have been applied, the OCPD of copper conductors for the following ratings are not allowed to be exceeded: 14 AWG = 15A, 12 AWG = 20A, 10 AWG = 30A.

Note 1: The NEC allows an exception to applying the 125% multiplier for continuous operation. It states "Circuits containing an assembly, together with its overcurrent device(s), that is listed for continuous operation at 100 percent of its rating shall be permitted to be used at 100 percent of its rating". However, when a breaker is listed for 100% continuous duty, the UL listing requires the breaker manufacturer to verify that the additional heat generated by 100% continuous loading conditions is safely dissipated in the enclosure during testing, and the breaker is labeled with specific information on the enclosure size and venting requirements. Be cautious if someone says their breaker is 100% continuous duty, but the breaker label does not mention specific information on the enclosure size and venting requirements.

2.6.4 Steps to Sizing Conductors and Overcurrent Protection in a PV System



Info: A worksheet to help size PV conductors and overcurrent protection devices using the following steps is provided in Appendix C.



Info: Tables referenced in this section are from the 2014 Edition of the National Electrical Code® (also known as NFPA 70).

To calculate the required conductor and the overcurrent protection device size, follow these steps:

Step 1 - Calculate the maximum current for the circuits (I_{MAX}).

Step 2 - Determine the conductor size for the continuous circuit currents (I_{CONT}).

a) Calculate the continuous current for the circuit (I_{CONT}).

b) Find the conductor sized for continuous current.

Look at Table 310.15(B)(16) and select the temperature rating column that corresponds to the lowest temperature rating of any terminal the conductor is terminated on, regardless of the insulation of the selected conductor. Select the smallest conductor that exceeds the continuous current (I_{CONT}) calculation from Step 2a.

Step 3 - Determine the conductor size for the maximum circuit currents derated after adjustment factors (I_{DERATE}).

a) Calculate the ampacity of the conductors after derating by the following “conditions of use” factors:

1. *Conduit Fill Factor (Fill Factor) – When more than three current carrying conductors are in conduit (or bundled together) in continuous lengths >24 inches, divide by the Conduit Fill Factor from Table 310.15(B)(3)(a).*

2. *Temperature Correction Factor (Temp Factor) - If the average ambient temperature (Avg. Temp)—in addition to the Rooftop Temperature Adder*—is greater than 30°C, then these two temperatures become the effective ambient temperature (Eff. Temp) value. Use this effective temperature to determine the appropriate Correction Factor** from Table 310.15(B)(2)(a).*

* *Rooftop Temperature Adder (Rooftop Add.) – Conductors/raceways exposed to sunlight on a roof require the ambient temperature to be increased—based on the distance from the roof—using a Temperature Adder from Table 310.15(B)(3)(c).*

***Correction Factor – To determine the correct temperature factor, the conductor’s temperature rating is required.*

b) Find the conductor sized after derating factors have been applied:

Look at Table 310.15(B)(16) and select the temperature rating column that corresponds to the lowest temperature rating of any terminal the conductor is terminated on, regardless of the insulation of the selected conductor. Select the smallest conductor that exceeds the derated current (I_{DERATE}) calculation from Step 3a.

Step 4 - Determine the minimum required conductor size.

Compare the conductor sized to the continuous current (Step 2b) against the conductor sized after derating factors (Step 3b); the largest conductor between the two is the minimum required conductor size.

Step 5 - Size the Overcurrent Protection Device (OCPD) to protect the selected conductor.

Ensure the size of the OCPD is equal to or greater than the Continuous Current (see Step 2) and less than or equal to the ampacity of the Minimum Required Conductor (see Step 4) using a commonly available size (see NEC Article 240.6).

Notes:

1. *If the OCPD is rated for 100% operation, then it can be sized to the lower I_{MAX} current (Step 1).*

2. *The OCPD for each PV source conductor cannot exceed the “Series fuse” listed on the module label.*

3. *Consult the manufacturer for OCPD rating if exposed to temperatures greater than 40°C.*

2.6.4.1 Example to determine the size of the PV System conductors and OCPD's

Find the PV System conductors and OCPD size:

Scenario: The PV system will be installed in an area where the average high temperature is 26°C. The array has three PV strings (six current-carrying conductors), these source conductors are bundled together and connect to a fused string combiner. The lowest temperature rating of any terminal is 75°C. The module's have a short circuit current rating (I_{SC}) of 6.99 amps and a maximum reverse current rating of 16 amps.

A) Find the PV Source circuit conductor and OCPD size:

Step 1 - Calculate the maximum current for the PV source circuits (I_{MAX}).

- Max current for PV source ($PV_{SOURCE-I_{MAX}}$) = Module I_{SC} x 1.25 = 6.99 x 1.25 = **8.74**

Step 2 - Determine the conductor size for the continuous currents (I_{CONT}).

a) Calculate the continuous current for the PV source circuits (I_{CONT}).

- Continuous current for PV source ($PV_{SOURCE-I_{CONT}}$) = $PV_{SOURCE-I_{MAX}}$ x 1.25 = 8.74 x 1.25 = **10.92**

b) Find the conductor sized for continuous current (Lowest terminal temperature = 75°C).

- Conductor sized to continuous currents = **14 AWG @ 75°C (20 amps)**.

Per Table 310.15(B)(16), 14 AWG is the smallest cable listed @ 75°C and rated 20 amps.

Step 3 - Determine the conductor size for the maximum currents for the PV source circuits derated after adjustment factors (I_{DERATE}).

a) Calculate the ampacity of the conductors after derating by "conditions of use" factors:

- Max PV source circuit current with conditions of use ($PV_{SOURCE-I_{DERATE}}$) = ($PV_{SOURCE-I_{MAX}} \div$ Fill Factor \div Temp Factor) = $8.74 \div 0.80 \div 1$ (no Temp Factor derate) = **10.93**

1. Conduit Fill Factor [from Table 310.15(B)(3)(a)] - adjustment for six current-carrying conductors bundled together is 80% (0.80).

2. Temperature Correction Factors (ambient temperature + rooftop adder) - there is no derate based on temperature. The ambient temperature is 26°C, so there is no derate as it is below 30°C. There is no rooftop adder because the PV source conductors are not installed close to rooftop.

b) Find the conductor size after derating factors have been applied:

(Lowest terminal temperature = 75°C, and using USE-2 (90°C) cable)

- Conductor sized after derating factors = **14 AWG @ 75°C (20 amps)**.

Per Table 310.15(B)(16), 14 AWG @ 90°C has an ampacity of 25 amps; however, since the terminal temperature is 75°C, the cable ampacity under the 75°C column is used. So, 14 AWG is the smallest cable listed under the @ 75°C column and is rated 20 amps.

Step 4 - Determine the minimum required conductor size: 14 AWG @ 75°C (20 amps).

The largest conductor between the continuous current conductor (Step 2b) and the derating factors conductor (Step 3b) is the minimum conductor size used, In this instance they are the same.

Step 5 - Size the Overcurrent Protection Device (OCPD) to protect the selected conductor.

The OCPD should be a commonly available size (see NEC Article 240.6), and sized to be:

- equal to or greater than the Continuous Current (see Step 2a) = 10.92; and*
- less than or equal to the Minimum Required Conductor ampacity (see Step 4) = 20 amps*

A 15 amp OCPD is recommended, this is the next highest standard value above the design current of 10.92 amps. This size will meet all requirements for each PV source conductor ampacity and is less than the maximum reverse current of 16 amps.

Note: If the OCPD is rated for 100% operation, then it can be sized to the lower I_{MAX} current (Step 1).

Note: The OCPD for each PV source conductor cannot exceed the "Series fuse" listed on the module label.

Note: Consult manufacturer for OCPD rating if exposed to temperatures greater than 40°C.

Find the PV System conductors and OCPD size (continued):

Continued Scenario: The PV output conductors of the combiner (two current-carrying conductors) run through conduit 2" above the rooftop and connect to a PV disconnect breaker installed in an MMP enclosure with a PT-100 charge controller. The lowest temperature rating of any terminal is 75°C.

B) Find the PV Output circuit conductor and OCPD size:

Step 1 - Calculate the maximum current for the PV output circuits (I_{MAX}).

- Max current for PV output ($PV_{OUTPUT-I_{MAX}}$) = Module I_{SC} x 1.25 x number of strings = 6.99 x 1.25 x 3 strings = **26.2**

Step 2 - Determine the conductor size for the continuous currents (I_{CONT}).

a) Calculate the continuous current for the PV output circuits (I_{CONT}).

- Continuous current for PV output ($PV_{OUTPUT-I_{CONT}}$) = $PV_{OUTPUT-I_{MAX}}$ x 1.25 = 26.2 x 1.25 = **32.8**

b) Find the conductor sized for continuous current (Lowest terminal temperature = 75°C).

- Conductor sized to continuous currents = **10 AWG @ 75°C (35 amps)**.

Per Table 310.15(B)(16), 10 AWG is the smallest cable listed above 26.2 amps @ 75°C.

Step 3 - Determine the conductor size for the maximum currents for the PV output circuits derated after adjustment factors (I_{DERATE}).

a) Calculate the ampacity of the conductors after derating by "conditions of use" factors:

- Max PV output circuit current with conditions of use ($PV_{OUTPUT-I_{DERATE}}$) = ($PV_{OUTPUT-I_{MAX}}$ ÷ Fill Factor ÷ Temp Factor) = 26.2 ÷ 1 (no Fill Factor derate) ÷ 0.76 = **34.5**

1. *Conduit Fill Factor* - there is less than three current carrying conductors, so there is no derate.
2. *Temperature Correction Factors (ambient temperature + rooftop adder)* - The ambient temperature is 26°C and there is a rooftop adder of 28C [per Table 310.15(B)(3)(c)] because the PV output conductors are installed 2" from the rooftop. The ambient temperature (26°C) + rooftop adder (28°C) give an effective temperature of 54°C. A temperature derate is required since this is greater than 30°C. Using Table 310.15(B)(2)(a), a USE-2 (90°C) cable at a temperature of 54°C uses a Temp Factor derate of 0.76.

b) Find the conductor size after derating factors have been applied:

(Lowest terminal temperature = 75°C, and using USE-2 (90°C) cable)

- Conductor sized after derating factors = **10 AWG @ 75°C (35 amps)**.

Per Table 310.15(B)(16), 14 AWG @ 90°C has an ampacity of 25 amps; however, since the terminal temperature is 75°C, the cable ampacity under the 75°C column is used. So, 14 AWG is the smallest cable listed under the @ 75°C column and is rated 20 amps.

Step 4 - Determine the minimum required conductor size: 10 AWG @ 75°C (35 amps).

The largest conductor between the continuous current conductor (Step 2b) and the derating factors conductor (Step 3b) is the minimum conductor size used, in this instance they are the same.

Step 5 - Size the Overcurrent Protection Device (OCPD) to protect the selected conductor.

The OCPD should be a commonly available size (see NEC Article 240.6), and sized to be:

- a) equal to or greater than the Continuous Current (see Step 2a) = 32.8 amps; and
- b) less than or equal to the Minimum Required Conductor ampacity (see Step 4) = 35 amps

A 35 amp OCPD is recommended, this is the next highest standard value above the design current of 32.8 amps. This size will meet all requirements for the PV output conductor ampacity.

Note: If the OCPD is rated for 100% operation, then it can be sized to the lower I_{MAX} current (Step 1).

Note: Consult manufacturer for OCPD rating if exposed to temperatures greater than 40°C.

Table 2-2, Allowable Conductor Ampacities

The table below shows the allowable ampacities of insulated copper conductors rated 0 through 2000 volts, 60°C through 90°C, not more than three current-carrying conductors in a raceway, cable, or earth (directly buried), based on ambient temperature of 30°C (86°F).

Conductor Size (AWG)	Ampacity for Temperature Rating Copper Conductor		
	60°C (140°F)	75°C (167°F)	90°C (194°F)
14*	15	20	25
12*	20	25	30
10*	30	35	40
8	40	50	55
6	55	65	75
4	70	85	95
3	85	100	115
2	95	115	130
1	110	130	145

Data taken from Table 310.15(B)(16) in the National Electrical Code® (2014 Edition)

* Per NEC® (2014 Edition), Section 240.4(D) for conductor overcurrent protection limitations. The overcurrent protection of these copper conductors after any correction factors have been applied for ambient temperature or number of conductors are limited to the following ratings: 14 AWG - 15A, 12 AWG - 20A, 10 AWG - 30A.

Table 2-3, Ambient Temperature Adjustments

Conductor ampacities must be derated when in ambient temperatures greater than 30°C (86°F). Find the allowable ampacities specified in the ampacity tables (from Table 2-2) and multiply by the appropriate correction factor shown below.

Ambient Temperature		Temperature Rating of Conductor		
(°C)	(°F)	60°C (140°F)	75°C (167°F)	90°C (194°F)
10 or less	50 or less	1.29	1.20	1.15
11-15	51 - 59	1.22	1.15	1.12
16 -20	60 - 68	1.15	1.11	1.08
21 - 25	69 - 77	1.08	1.05	1.04
26 - 30	78 - 86	1.00	1.00	1.00
31 - 35	87 - 95	0.91	0.94	0.96
36 - 40	96 - 104	0.82	0.88	0.91
41 - 45	105 - 113	0.71	0.82	0.87
46 - 50	114 - 122	0.58	0.75	0.82
51 - 55	123 - 131	0.41	0.67	0.76
56 - 60	132 - 140	-	0.58	0.71
61 - 65	141 - 149	-	0.47	0.65
66 - 70	150 - 158	-	0.33	0.58
71 - 75	159- 167	-	-	0.50
76 - 80	168 - 176	-	-	0.41
81 - 85	177 - 185	-	-	0.29

Data taken from Table 310.15(B)(2)(a) in the National Electrical Code® (2014 Edition)

Table 2-4, Rooftop Distance Adjustments

Distance Above Roof to Bottom of Raceway or Cable	Temperature Adder	
	(°C)	(°F)
0 to 13 mm (0 to ½ in.)	33	60
Greater than 13 mm (½ in.) to 90 mm (3½ in.)	28	50
Greater than 300 mm (12 in.) to 900 mm (36 in.)	14	25

Data taken from Table 310.15(B)(3)(c) in the National Electrical Code® (2014 Edition)

Table 2-5, Multiple Conductors in Raceway/Cable Adjustments

Number of Conductors*	Conduit Fill Adjustment Factor
4 - 6	80% (0.80)
7 - 9	70% (0.70)
10 - 20	50% (0.50)
21 - 30	45% (0.45)
31 - 40	40% (0.40)
41 and above	35% (0.35)

Data taken from Table 310.15(B)(3)(a) in the National Electrical Code® (2014 Edition)

* Three current carrying conductors in conduit or bundled together in continuous lengths greater than 24 inches (excludes grounding conductors).

2.7 Wiring the PT-100

This section describes the requirements and recommendations for wiring the PT charge controller. The NEC (National Electric Code, ANSI/NFPA 70) for the United States and the CEC (Canadian Electrical Code) for Canada provide the standards for safely wiring residential and commercial installations.



WARNING: Wiring to the PT charge controller should meet all local codes and standards and be performed by qualified personnel such as a licensed electrician.



WARNING: Ensure all power (i.e., batteries, solar) is de-energized (i.e., breakers opened, fuses removed) before proceeding—to prevent accidental shock.



CAUTION: The PT controller is NOT reverse polarity protected—which means that if the negative and positive voltage (from either the PV or battery) is connected backwards to the charge controller, the charge controller will likely be damaged. You should verify the correct voltage polarity using a voltmeter BEFORE connecting any wires.

2.7.1 Wiring Requirements

- All PV and battery conductors that are at risk for physical damage must be protected by conduit, tape, or placed in a raceway; and any knockout opening on the controller wiring box must be protected with conduit or with a bushing.
- Always check for existing electrical, plumbing, or other areas of potential damage prior to making cuts in structural surfaces or walls.
- To prevent electrical interference, do not mix power wires (i.e., PV and/or battery) in the same conduit or panel with signal/communications wires.
- The PT controller disconnects the PV input from the battery during night time or low sunlight conditions; this means blocking diodes are not required to prevent reverse current leakage.
- DC overcurrent protection for the PV and battery wires must be provided as part of the installation.
- The negative-to-ground connection is provided in the charge controller. Negative should not be bonded to ground anywhere else in the system to ensure the GFDI circuit operates correctly.
- Use only copper wires with a minimum temperature rating of 75°C. The wire sizes recommended are based on the ampacities given in Table 310.16 (in conduit) of the NEC, ANSI/NFPA 70, for 75°C (167°F) copper wire and based on an ambient temperature of 30°C (86°F).
- The NEC requires DC overcurrent protection for the PV and battery wires; and that the DC circuit conductors and overcurrent devices from the photovoltaic system to the charge controller and from the charge controller to the battery bank be sized to carry not less than 125% of the circuit's maximum output current rating.
- To ensure the maximum performance from the controller, all connections from the battery bank to the controller should be minimized. The exception is the DC overcurrent disconnect in the positive line and a shunt in the negative line. Any other additional connections will contribute to additional voltage drops and may loosen during use.
- All wiring to the terminals should be checked periodically (once a month) for proper tightness. If you don't have a torque wrench, ensure all DC terminals are tight and cannot move.
- Color code the DC wires with colored tape or heat shrink tubing: RED for positive (+); WHITE for negative (-); and GREEN (or bare copper) for DC ground, to avoid polarity problems.
- PV module interconnections should be 90°C wet-rated conductors. Allowable wire types are:
 - USE-2 single conductor cable for exposed applications
 - Type TC multi-conductor cable for exposed applications with THWN-2 or XHHW-2 or RHW-2 or equivalent 90°C wet-rated conductors in the cable.
 - Type THWN-2 or XHHW-2 or RHW-2 or equivalent 90°C wet-rated conductors in high temperature conduit (conduit rated for a minimum of 75°C wet conditions).
- All wiring should be sized to minimize voltage drop.
- Ensure all wires and conduit are correctly secured/supported.
- The insulation of the wires (both power and communication) must be rated to handle the highest voltage within the wiring access area.

2.7.2 Wire Routing

Before connecting any wires, determine all wire routes to and from the charge controller, such as:

- PV input wiring from the PV array/combiner to the charge controller
- Battery output wiring from the charge controller to the batteries
- Battery Temperature Sensor cable from the charge controller to the batteries
- Network cable from the charge controller to the inverter (optional)
- Ground wiring to and from the charge controller
- Auxiliary relay wiring to and from the controller wiring compartment

2.7.3 Torque Requirements

Follow the specific torque recommendations below to ensure your fasteners are tightened sufficiently. To ensure your connections are correct, you should use an accurate, quality torque screwdriver/wrench. It is highly recommended to go back over all fasteners and re-torque after 5 days—and every 6 months thereafter.



CAUTION: DC power/wire connections that are under-torqued could become loose and result in a fire hazard. On the other hand, over-tightening a screw/bolt could cause the fastener to be snapped off.

Table 2-6, Torque Values for the DC Terminal Block

Wire Size	#2 Phillips Screw Torque Value
#20 to 1 AWG (0.5 to 42.4 mm ²)	30 in lbf (3.4 N-m)

Table 2-7, Torque Values for the Ground Busbar

(this busbar has different torque values for the small and large screws)

Wire Size	Busbar Screw Size Torque Values	
	10-32 (Small Screw)	5/16-24 (Large Screw)
#14 to 10 AWG (2.08 to 5.26 mm ²)	15 in. lbs. (1.7 N-m)	35 in. lbs. (4.0 N-m)
8 AWG (8.36 mm ²)	20 in. lbs. (2.3 N-m)	40 in. lbs. (4.5 N-m)
6 AWG (13.3 mm ²)	25 in. lbs. (2.8 N-m)	45 in. lbs. (5.1 N-m)
4 AWG (21.1 mm ²)	NA	45 in. lbs. (5.1 N-m)
#3 to 1/0 AWG (26.7 to 53.5 mm ²)	NA	50 in. lbs. (5.6 N-m)

2.7.4 PT-100 Output Conductor Size

It is important to use the correct sized DC wire to achieve maximum efficiency from the system and to reduce fire hazards associated with overheating. Always keep your wire runs as short as practical. For correctly sizing the PV source and PV output conductors (and corresponding overcurrent device) see Section 2.6. For the PT-100 output, use the conductor size listed in Table 2-8, which is based on the PT-100's maximum output current rating ($I_{MAX} = 100$ amps).

If the distance from the charge controller to the battery bank is >5 feet, the DC wire will need to be increased. Longer distances cause an increase in resistance, which affects the charging performance to the battery. Use the conductor size listed in the lower part of Table 2-8 to determine the minimum DC wire size needed for various distances.

2.7.5 Overcurrent Protection for the PT-100 Output Conductor

In a residential or commercial electrical installation, the NEC requires both overcurrent protection and a disconnect switch for all circuits in the PV system. A DC overcurrent protection device (OCPD) must be installed in the positive DC conductor side¹, it can be a fuse or a circuit breaker, and must have the appropriate DC voltage, current, and interrupt ratings. It must be correctly sized according to the size of the DC conductor being used, which means it is required to open before the conductor reaches its maximum current carrying capability, thereby preventing a fire. If a circuit breaker is used as the overcurrent protection device, it can also be used as the required DC disconnect. Since the PT-100 is energized from more than one source (PV and battery), a separate PV and battery disconnect is required. The disconnects in the system must be able to be manually operable without exposing the operator to contact with live parts, grouped together and identified, be readily accessible, and plainly indicated whether they are in the ON (closed) or OFF (open) position.

For information on correctly sizing the OCPD for the PV source and PV output conductors, see Section 2.6. For the PT-100 output, use the DC overcurrent device in Table 2-8, which is used to protect the recommended minimum wire size for the PT-100 charge controller.



Info: The MP and MMP Series panels which have been specifically designed to conveniently connect a Magnum inverter and the PT-100 charge controller together. These panels allow the PT-100's required PV and battery DC disconnects and all wire connection points to be connected together, accessible from the front, and marked in an easy to install pre-wired enclosure.

Table 2-8, Recommended DC Wire/Overcurrent Device for PT-100

Charge Controller Model	Maximum Continuous Output Current	Recommended OCPD (DC Breaker) Size ²	Using Conduit	In Free Air	DC Grounding Electrode Wire Size ⁴
			Minimum DC Wire Size ³ [rating]	Minimum DC Wire Size ³ [rating]	
PT-100	100 amps	125 amps	1 AWG (42.4mm ²) [130 amps]	4 AWG (21.1mm ²) [125 amps]	6 AWG (13.3mm ²)

▼ ▼

Increased size for longer distance	5 to 10 feet =	1 AWG (42.4mm ²)	2 AWG (33.6mm ²)
	10 to 15 feet =	1/0 AWG (53.5mm ²)	1 AWG (42.4mm ²)

- Note¹** – The PT-100 can only be installed in a negative-grounded system.
- Note²** – If the OCPD is rated for 100% continuous operation, then it can be sized to 100 amps.
- Note³** – Copper wire rated with 75°C (167°F) insulation at an ambient temperature of 30°C (86°F). If using conduit, temperature and cable fill derating maybe required—they were not applied in this calculation.
- Note⁴** – Per the NEC, the DC grounding electrode conductor can be a 6 AWG conductor if that is the only connection to the grounding electrode and that grounding electrode is a rod, pipe, or plate electrode.

2.7.6 Equipment Grounding Conductor

The PT controller case and all other noncurrent-carrying exposed metal surfaces in the entire electrical system that may be accidentally energized must be grounded. The equipment-grounding conductor must be sized to safely carry the maximum ground-fault current likely to be imposed on it from where a ground-fault may occur. In accordance with the NEC, use Table 2-9 to size the equipment-grounding conductors. This table requires that the equipment-grounding conductor be sized according to the rating of the overcurrent device protecting the circuit.



CAUTION: The grounding conductor wiring must be continuous to allow fault currents to properly operate overcurrent devices. If equipment is removed which disconnects the bonding connection between the grounding electrode conductor and exposed conducting surfaces, a bonding jumper must be installed while the equipment is removed.

The DC equipment grounding conductor is sized per Table 2-9 and connected to the DC equipment grounding Busbar on the charge controller as shown in Figure 1-2, Item 9.

Note: The PT-100 is rated for 100 amps full charging output. This output is normally sized with a 125 amp overcurrent device, which would require a 6 AWG (13.3 mm²) copper ground wire.

Table 2-9, Equipment Grounding Conductor Sizing

Rating of Overcurrent Device	Minimum Size of Copper Ground Wire
15 amps	14 AWG (2.1 mm ²)
20 amps	12 AWG (3.3 mm ²)
30 to 60 amps	10 AWG (5.3 mm ²)
100 amps	8 AWG (8.4 mm ²)
200 amps	6 AWG (13.3 mm ²)
300 amps	4 AWG (21.1 mm ²)
400 amps	3 AWG (26.7 mm ²)

2.7.7 Wiring for the Internal GFDI

The PT-100 charge controller is equipped with GFDI (Ground Fault Detection/Interruption) capability and the normal factory default is with the GFDI feature enabled (DIP switch 2 is down). With the GFDI enabled, the PV negative and battery negative lines must be wired so that they are floating with respect to ground—the single point of ground for the DC system is made within the PT controller through its internal 0.5 amp GFDI fuse. The GFDI fuse inside the PT-100 provides the system negative-to-ground bond and is used to detect ground-faults in a negative grounded PV array system, which is common in North American installations. See Section 4.5 for more information on the operation of the Ground Fault Protection circuitry.

If an external GFDI device will be used in the PV system, then the controller’s internal GFDI feature must be disabled (push DIP switch 2 to UP) and the GFDI fuse must be removed. See Section 5.5 for information on removing the GFDI fuse.



CAUTION: If GFDI protection is enabled, the PV negative and battery negative circuits are grounded inside the PT controller. DO NOT ground the PV negative or battery negative circuits in any other location, or the GFDI protection feature in the PT-100 charge controller will be defeated.

2.7.7.1 GFDI Label

In a photovoltaic system that has a Ground Fault Protection device, the NEC requires the installer to apply a warning label near the ground fault indicator in a visible location, stating the following:

WARNING: ELECTRIC SHOCK HAZARD
IF A GROUND FAULT IS INDICATED, NORMALLY GROUNDED
CONDUCTORS MAY BE UNGROUNDED AND ENERGIZED.

When the photovoltaic system also has batteries, the same warning is also required to be posted by the installer in a visible location at the batteries.

This warning sign/label(s) shall comply with section 110.21(B) of the NEC, which states:

1. The WARNING label shall use the following colors: Black text with white and orange background.
2. The label shall be permanently affixed to the equipment and shall not be handwritten.
3. The label shall be of sufficient durability to withstand the environment where it is installed.

A label as shown in Figure 2-16 that complies with the NEC requirements is provided with the PT-100.



Info: When the PT controller’s ground fault protection circuit is enabled and a ground fault is detected, the fault indicator comes on and **F12** is displayed on the PT controller.



Figure 2-16, Ground Fault Label

2.7.8 Terminal Block Connections

The charge controller provides a four-pole, high power (125-amps), 600-volt rated, DC terminal block and a ground busbar to connect the PV input and battery output wires. Each connection on the terminal block is rated up to 75°C and can accept one #20 to 1 AWG (0.5 to 41.0 mm²) wire. Use a #2 Phillips head screwdriver to tighten each connection to a recommended tightening torque of 30 in lbf (3.4 N-m).

The ground busbar uses five slotted head screw-type compression terminals (no ring lugs required) and accepts CU stranded wire. Three of the terminals use a small 10-32 screw, and the other two use a larger 5/16-24 screw. See Table 2-7 for the acceptable wire sizes and recommended tightening torque values for these screws.



WARNING: Before making any wire connections, make sure the charge controller is not connected to the battery and there is no PV power (cover all panels and open all PV source breakers/fuses).

DO NOT close the PV or battery circuit breaker to connect power to the charge controller at this time. This will occur in the **Functional Test** after the installation is complete.



Info: The charge controller's PV- and BAT- terminals are electrically connected to each other internally and either connection can be used for the input or output negative.

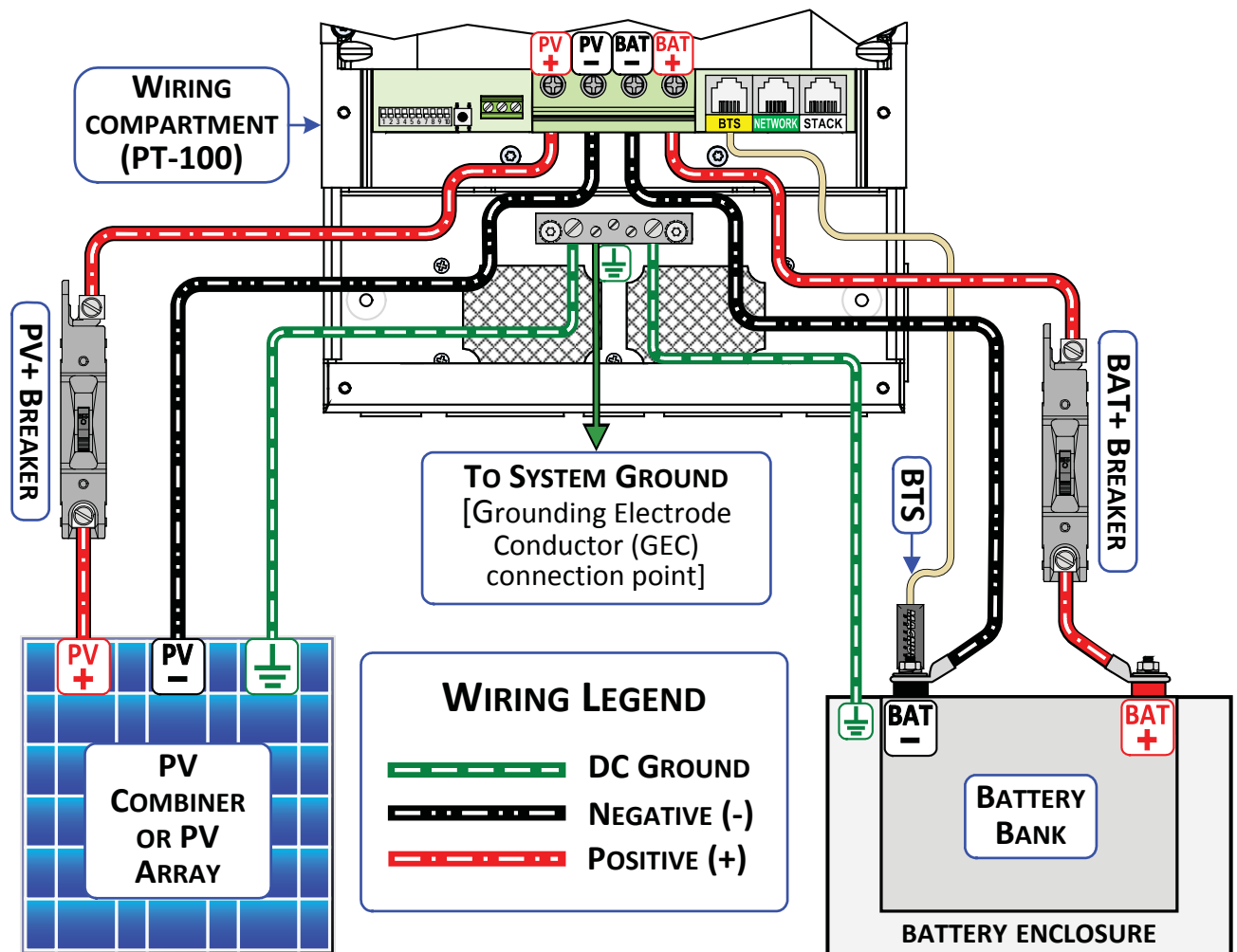

Figure 2-17, Wiring to DC Terminal Block

2.7.9 Steps to Wiring the PT-100

The following steps are basic guidelines for connecting PV and battery wiring to and from the PT-100 charge controller. Remove the four Phillips screws on the wiring access cover to access the terminal block (see Figure 2-2). Refer to Figure 2-17 while making the connections.



WARNING: Before making any wire connections, make sure the charge controller is not connected to the battery and there is no PV power (cover all panels and open all PV source breakers/fuses).

DO NOT close the PV or battery circuit breaker to connect power to the charge controller at this time. This will occur in the **Functional Test** after the installation is complete.



CAUTION: The PT controller is NOT reverse polarity protected—if the positive line is connected to the negative terminal of the charge controller and vice versa, severe damage will result and will not be covered under warranty. Verify the correct PV and battery voltage and polarity using a voltmeter BEFORE connecting.

Wiring the charge controller PV input

1. Route the PV output wires (PV Positive, PV Negative, and PV Ground) from the PV combiner to the charge controller.
2. Connect the positive wire (red or black) from the PV combiner to a dedicated PV breaker (ensure the breaker is open), then to the charge controller's PV+ terminal.
3. Connect the negative wire (white) from the PV combiner to the charge controller's PV- terminal.
4. Connect the ground wire (green or bare copper) from the PV combiner to the charge controller's ground busbar.

Wiring the charge controller battery output

1. Route the battery wires (ground, positive and negative) from the charge controller to the battery bank.
2. Connect the ground wire (green or bare copper) from the charge controller to the battery ground terminal.
3. Connect the positive wire (red or black) from the charge controller to a dedicated battery breaker (ensure breaker is open) then to the battery positive (+) terminal.
4. Connect the negative wire (white) from the charge controller to the battery negative (-) terminal.

Note: If installing a battery monitor such as the ME-BMK, install a DC shunt in-line with the negative battery cable.



Info: Ensure the connections to the batteries are flush on the surface of the battery terminals, and the hardware is (lock washer and nut) used to hold these connections are stacked correctly (see Figure 2-19).

2.7.10 Wiring the Battery Bank



WARNING: Lethal currents will be present if the positive and negative cables attached to the battery bank touch each other. During the installation and wiring process, ensure the cable ends are insulated or covered to prevent touching/shorting the cables.

Depending upon the voltage of the batteries you use in the installation (6 or 12 VDC), the batteries must be wired in series, parallel, or series-parallel to provide the correct voltage. Once the battery connections are completely wired and tested, cover the terminals with an approved anti-oxidizing coating.

Place the batteries as close as practical to the charge controller, preferably in an insulated and ventilated enclosure. DO NOT mount the batteries directly under the charge controller. Allow adequate space above the batteries to access the terminals and vent caps (as applicable). Also, allow at least 1" (2.5 cm) of space between the batteries to provide good air flow.



Info: To ensure the best performance from your charge controller system, batteries should be of the same size, type, rating, and age. Do not use untested batteries.

2.8 Wiring the Battery Temperature Sensor

The Battery Temperature Sensor (BTS) shown in Figure 2-18, allows the charge controller to automatically adjust the charge voltage set-points to correctly charge the batteries under extreme temperature changes. If the temperature sensor is NOT installed and the batteries are subjected to large temperature changes, the life of the battery may be shortened.

If the PT controller is networked to a Magnum inverter with its own BTS, all temperature readings are provided by the inverter BTS. Therefore, a BTS is not required to be connected to the PT controller.



Info: If the voltage from the PV array is greater than 125V, the provided 300V rated extension cable (see Figure 2-22) must be used inside the access compartment to connect the BTS to the controller.

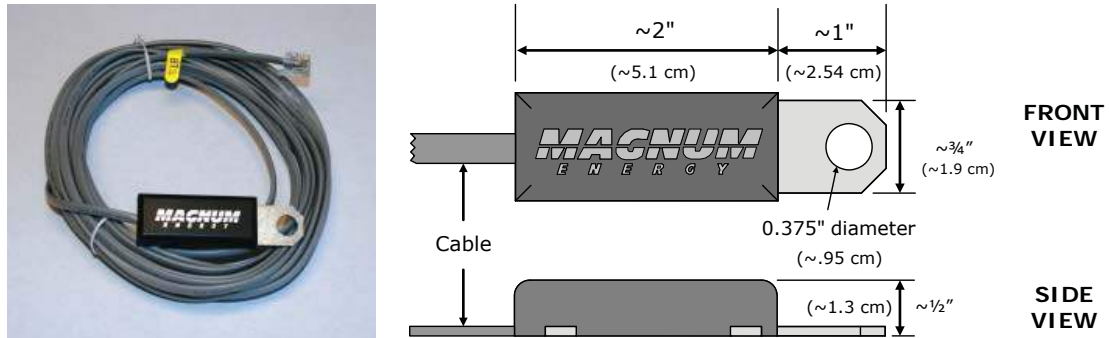

Figure 2-18, Battery Temperature Sensor

2.8.1 Connecting the BTS to the Battery Bank

The BTS should be connected to the negative battery post. However, when connecting the BTS, the BTS terminal should NOT be placed directly against the battery post. Instead, all power cables (charge controller and inverter) should be placed on the battery terminal first, then place the BTS terminal on the power cable terminals. Refer to Figure 2-19 to stack the battery cable and BTS terminal hardware correctly. Incorrectly installed hardware causes a high resistance connection which could lead to poor charge controller performance, and may melt the cable and terminal connections.



Info: The BTS terminal can be connected to either the positive or negative battery post - electrically, it does not matter. However, we recommend connecting the BTS to the negative battery post to help avoid the possibility of an electrical short.

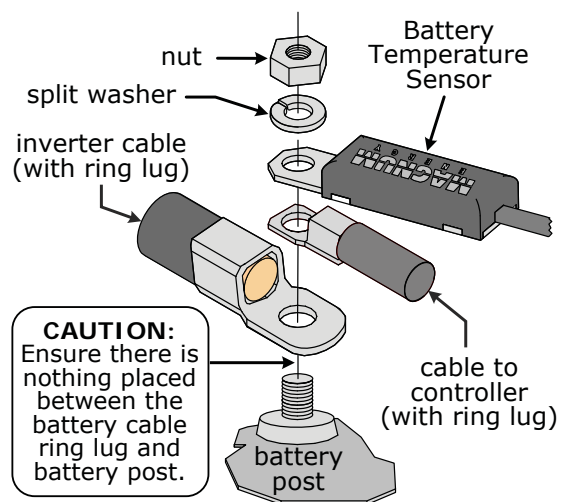

Figure 2-19, BTS and Battery Cable Hardware Installation

2.8.2 Connecting the BTS to the PT Controller

1. After placing the controller negative cable (and inverter battery cable, if used) on the battery negative post, attach the ring terminal end of the BTS to the battery post.
2. Route the BTS cable to the charge controller following existing communication wire runs.



Info: To prevent electrical interference in the BTS cable, it should not be routed in the same conduit as the power cables (i.e., PV wiring and battery cables).

3. Connect the RJ11 connector end of the BTS cable to the yellow-labeled BTS port on the charge controller (Figure 1-2, Item 13).

2.9 Wiring the Auxiliary Relay

The PT controller contains an internal auxiliary (aux) relay used to turn an external DC device on or off. The aux relay is wired through an on-board 3-port connector (see Figure 1-2, Item 6). When the PT controller is configured as a standalone controller, this aux relay only engages when there is a controller fault.

When configured as a network controller, this relay can indicate when a PT controller fault has occurred and can also be programmed to automatically engage or disengage based on high or low battery voltage. For example, this relay can be used to drive a relay for DC load control, or to turn on devices such as a battery compartment vent fan or a DC indicator light (see Figure 2-20). For more information on the relay's operation, refer to Section 4.10.

Auxiliary Relay Information

- The relay is a single-pole, double-throw (SPDT) relay provided with the NC (Normally Closed), COM (common), and NO (Normally Open) contacts (see Figure 2-20).
- Any voltage connected to the relay must be less than or equal to the relay's contact ratings (Contact Ratings: up to 30 VDC @ 5 amps, and from 31 VDC up to 100 VDC @ 0.5 amp).
- Disengages/opens if power to the PT controller or network communications (provided through the inverter network cable) is lost.
- Provides "dry contact" connections (it does not provide any voltage or current); so for any external device that requires voltage or current, it must be provided externally and routed through the relay. This relay is not intended to directly provide power. Rather, this relay can be used to send a signal to operate the coil of another higher amperage device that does the actual switching of power.
- An in-line fuse rated up to 5 amps (up to 30 VDC) or 0.5 amp (from 31 VDC to 100 VDC) must be used to protect all power circuits connected to the aux relay (do not fuse ground connections). The fuse should be located as close as possible to the power source. A fuse must be used, even if the circuit is providing only a "dry contact" or "ground" connection—it will prevent damage if the connection is miswired or damaged. Ensure the fuse is correctly rated for the wire size used. Refer to national and local codes for fuse rating and type. Be aware that damage to the relay is not covered under warranty.
- The aux relay circuit is not rated for AC volts and may cause damage if connected/used.

Terminal Block Information

- The aux relay is wired through an Euro-style connector (see Figure 1-2, Item 6).
- The connector provides a three-port slotted screw-type terminal block for wiring—requiring a #2-3 slotted screwdriver (9/64 or 3.5 mm tip width).
- Each port on the terminal block accepts a single wire from #26 to 12 AWG (0.13 to 3.3 mm²).

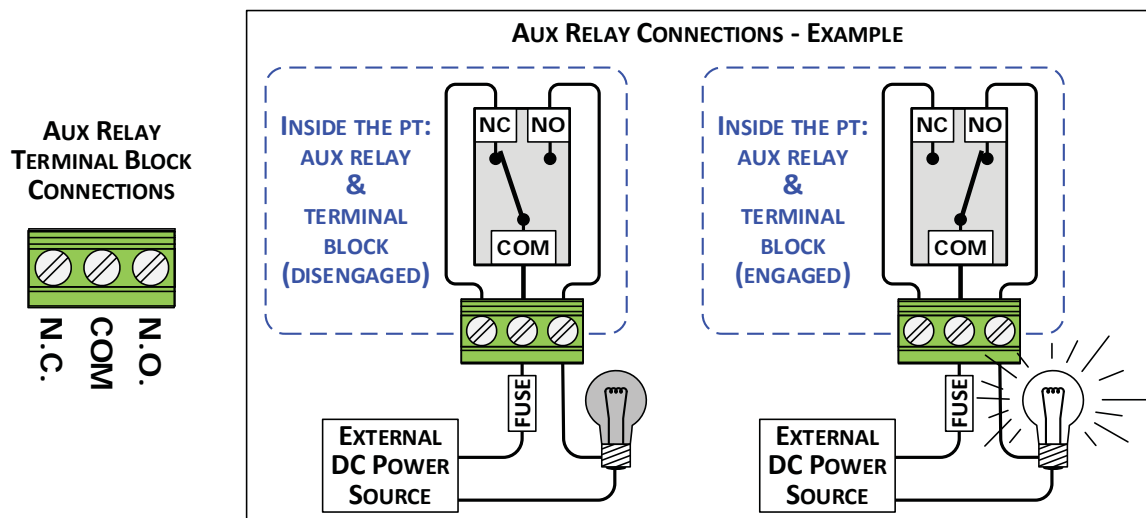

Figure 2-20, Auxiliary Relay Connections and Example

2.10 Network Wiring

2.10.1 Communications Cables - Provided

The NEC/CEC requires the insulation of all conductors inside the PT controller to be rated for the highest voltage present. The PT controller is designed to work with voltages up to 240 volts, therefore, the voltage rating of the communications cables inside the MP enclosure must be rated for 240 volts or higher to be code compliant. With the purchase of the PT-100, three six-foot, yellow communication cables with 300-volt rated insulation are provided. These communications cables—shown below—are provided to make the connections between the PT controller and any Magnum network device easier and code compliant. DO NOT substitute for the supplied cables—most cables do not contain the properly rated insulation.



Info: These cables carry less than 30 volts and are thus considered a “limited energy circuit”, which is normally not required to be installed in conduit.

Figure 2-21 shows the ‘NETWORK’ cable. It allows the PT controller to be networked to a Magnum inverter and remote. This cable is a 6’ (1.83 m), 4-conductor, telephone-type with a male RJ14 6P4C (6-position/4-conductor) connector and a green NETWORK label on each end. One end of this cable is connected to the inverter, and the other end is routed to the controller and connected to the NETWORK port inside the controller’s wiring area. See Figure 2-24.



Figure 2-21, NETWORK Communication Cable (300V Rated)

Figure 2-22 shows the ‘EXTENSION’ cable. It allows the Battery Temperature Sensor (BTS) to be connected to the controller. This is a 6’ (1.83 m), 4-conductor, telephone-type cable with a male RJ14 6P4C (6-position/4-conductor) connector on one end and a female RJ14 plug on the opposite end. The female plug connects to the ME-BTS (Battery Temperature Sensor). After connecting to the ME-BTS, this extension cable is routed to the controller and connected to the BTS port inside the controller’s wiring area.



Figure 2-22, Extension Cable (300V Rated)

2.10.2 Connecting the Network Cable

One end of the network cable plugs into the NETWORK (green) port on the PT controller, and the other end plugs into the NETWORK (green) port on the Magnum inverter/charger (see Figure 2-24).

Note: The network cable can be extended up to a length of 200 feet without data degradation. However, the PT controller and inverter must be connected to the same battery bank.

Note: If you are installing a BMK (Battery Monitor Kit), be sure to connect the splitter to the inverter’s NETWORK port, not to the PT’s NETWORK port.

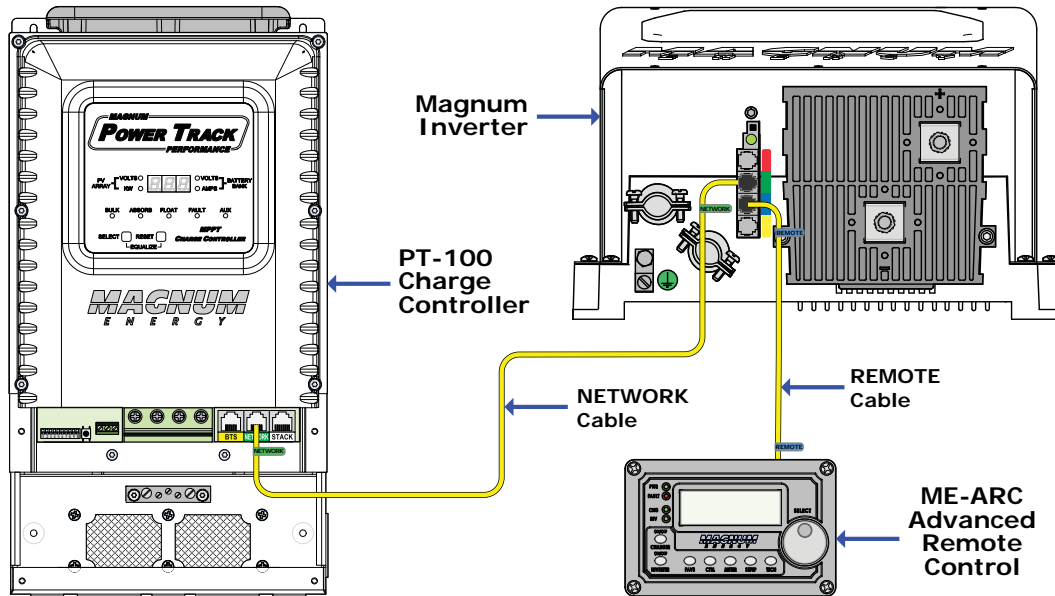

Figure 2-23, Connecting the PT-100 to the Magnum Inverter

2.10.3 Remote Compatibility

The PT charge controller, when connected to a Magnum inverter and remote, has many advanced features. The PT controller, inverter and remote communicate with each other to allow these advanced features to be set up or enabled. The inverter has no compatibility limitation when networked with a PT controller. However, the remote is required to have a minimum software revision to monitor and set up the PT controller. Refer to Table 2-10 to determine the remote revision required for viewing and configuring the PT controller.

Table 2-10, Remote Compatibility Revision

Remote Models	Revision with PT Menu's
ME-RC	NA
ME-ARC	≥ Revision 4.0
ME-RTR	NA

Note: If your remote is below the required revision level to work with your PT controller, contact Sensata to determine if there is a software upgrade option for your remote.

Note: To view the remote's software revision level, push the TECH button on your remote and access the Revisions menu.

2.11 Final Inspection/Tests

1. Verify all cables/conduit runs are secured, and verify strain reliefs or grommets are in place to prevent damage to the wiring or conduit where it passes through walls or other openings.
2. Ensure that all conduit connections are clean and tight, and are properly sealed against any environmental concerns.
3. Verify all DC connections (battery and PV) are correct and torqued properly.
4. Thoroughly inspect the charge controller and each component prior to energizing. Verify that no tools or materials have been inadvertently left behind or fallen inside.
5. If required by code, have the installation inspected by an electrical inspector.

2.11.1 Functional Test

After all electrical connections to the charge controller, batteries, and PV array have been completed, follow these steps to test the installation and the charge controller's operation.



WARNING: DO NOT connect power from the PV or the battery bank to the charge controller until 1) all PV and battery wiring is complete and connected to the correct terminals, 2) the correct PV and battery overcurrent protection has been installed, and 3) the correct DC voltage and polarity have been verified.



CAUTION: Use a multimeter to ensure the polarity of the battery and PV voltage to the controller is correct (positive connected to the appropriate charge controller positive terminal and the negative connected to the appropriate charge controller negative terminal). Ensure the multimeter is rated to measure the maximum PV voltage.

1. Before closing/connecting the battery disconnect, ensure the battery voltage to the charge controller is within the intended range of the configured battery bank (i.e., 24-32 volts for a 24-volt battery bank) and the polarity of the battery voltage to the controller is correct.



Info: To verify the polarity of the battery voltage to the controller is correct, use a DC voltmeter and touch the red test probe to the terminal of the battery disconnect breaker that is located on the battery positive (+) side. Use the black test probe of the DC voltmeter and touch it to the battery negative (-) terminal on the PT controller. If the polarity is correct, the multimeter will show a positive (+) indication.

2. If the battery voltage is within the PT-100 input requirements and polarity is correct, apply battery power to the PT controller by closing the battery disconnect breaker, but DO NOT connect the PV array at this time. The PT controller will go thru a power-up test by turning on each segment of the display and all LED indicators, this is followed by the internal alarm beeping three times, displaying the detected nominal battery voltage and then the software version (see Figure 2-27). After the software version has displayed, the power-up test is finished; the display will begin auto-scrolling and the controller begins to operate.
3. Before closing/connecting the PV disconnect, ensure the PV output voltage of the charge controller is less than $V_{bat} + 200VDC$ (or 240VDC maximum) and the polarity of the PV voltage to the controller is correct.
4. If the PV voltage is within the PT-100 input requirements and the polarity is correct, then close the PV disconnect breaker to apply PV power to the charge controller's PV input. After the PV input power is qualified (approximately 15 seconds), the controller will begin charging the battery (if sufficient power from the PV array is available). Verify the charge controller's display and charge status indicator are functioning (see Section 4.1).



Info: To verify the polarity of the PV voltage to the controller is correct, use a DC voltmeter and touch the red test probe to the terminal of the PV disconnect breaker that is located on the PV positive (+) side. Use the black test probe of the DC voltmeter and touch it to the PV negative (-) terminal on the PT controller. If the polarity is correct, the multimeter will show a positive (+) indication.

If the charge controller passes all the steps, the charge controller is ready for use. If the charge controller fails any of the steps or the fault light comes on, refer to the Troubleshooting section in this manual.

2.11.2 Power-up Test

When the controller is connected to DC power (either PV or battery), a diagnostic power-up test is performed (refer to Figure 2-25). This power-up test takes approximately 12 seconds to complete and verifies that all of the front panel LED's and the display come on and stay on until the test is complete. During this power-up test, the internal beeper is heard three times, each segment of the 3-character digital display turns on, and all nine LED indicators come on and stay on in sequence. Right before the power-up test ends, the display shows the controller's internal software version (e.g., 1.00) and then the nominal battery voltage that was detected (i.e., 12, 24 or 48 volts)¹.

When the power-up test has finished, the display should begin auto-scrolling thru the operational screens. If the power-up test did not perform correctly or a fault occurs (F## code displays), refer to Section 5.0, "Maintenance and Troubleshooting" for diagnostic help.

Note 1: The system voltage switches are set to AUTO (default) from the factory. If the battery voltage is well below the nominal battery voltage and the voltage that was displayed (i.e., 12, 24 or 48 volts) is incorrect for your battery bank, change DIP switches 3 and 4 to the correct nominal voltage setting (see Section 3.1).

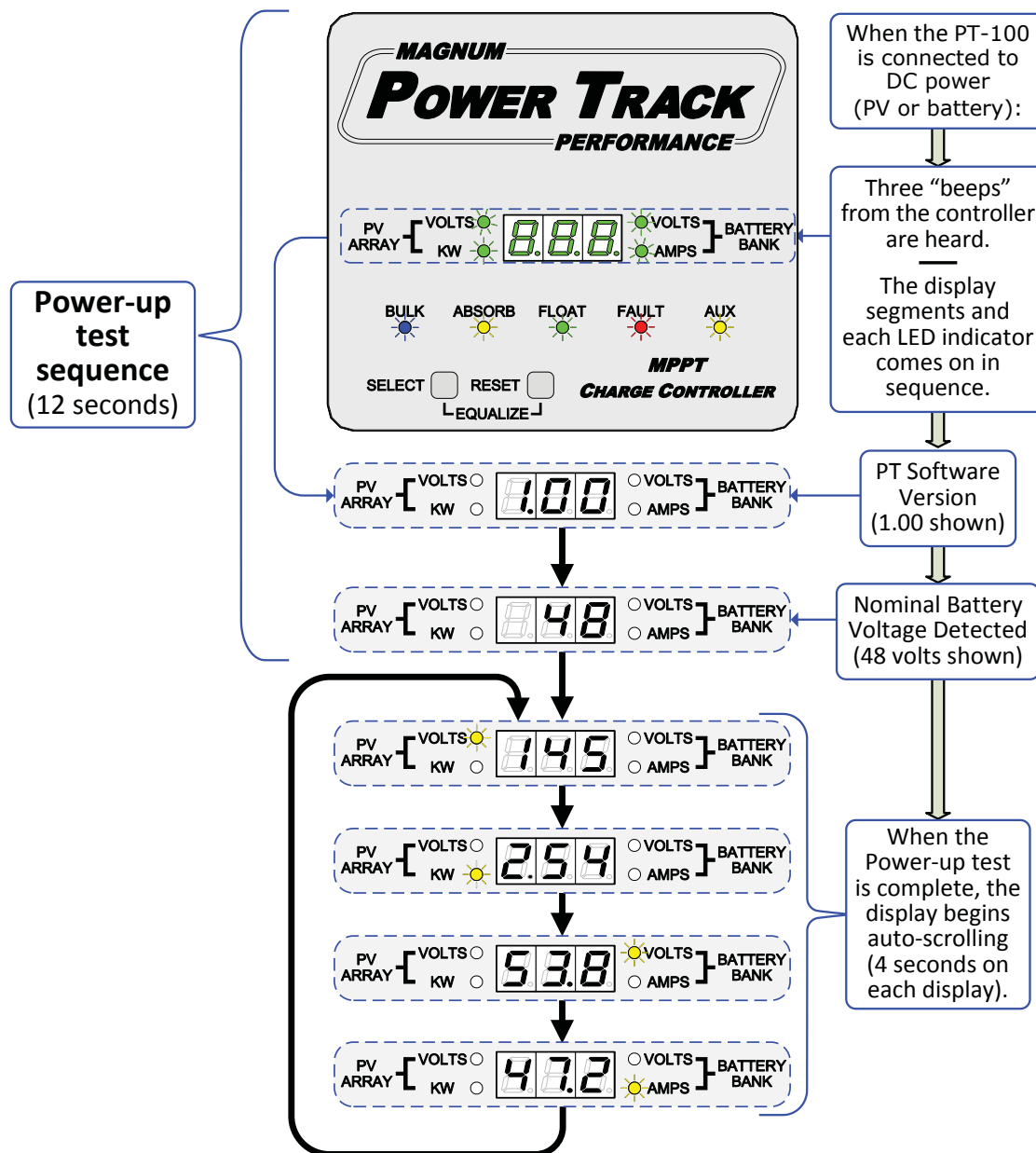

Figure 2-24, Power-up Test Displays

3.0 Setup

When the PT controller is not connected to a Magnum inverter/remote, the internal DIP switch (Figure 1-2, Item 4) is used to determine the PT controller's operation.



Info: When the PT controller is connected and networked with a Magnum inverter and remote, the remote is used to set up and/or control the PT controller's operation. Refer to the appropriate remote owner's manual for setup information (see Section 2.10.3).

3.1 Adjust DIP Switch Settings

The DIP (Dual In-line Package) switch includes 10 individual slide switches that can be in the UP (on) or DOWN (off) position. As a standalone PT controller, the arrangement of the 10 switches determines the operating parameters. The default setting (all DIP switches DOWN) is adequate for most installations, however, you have the option to change some of the operating parameters. This section shows how to change the DIP switch and gives an understanding of the function of each switch setting. Follow the DIP switch adjustments described below to configure the PT controller.



CAUTION: The PT controller cannot warn against or disallow incorrect DIP switch settings. Ensure the settings used to charge the batteries—the Absorption Done Time selection and the Battery Type selection—are checked carefully against the battery specifications. Incorrect settings may damage the battery or shorten battery life.



Info: When changing any DIP switch, make sure each switch is fully in the UP or DOWN position as needed. After making a DIP switch change, all power to the PT controller must be cycled (i.e., removed and reconnected) before a switch setting becomes effective.



Info: If networked, the remote overrides all DIP switches except for switches 1 (AFP), 2 (GFDI) and 10 (Stack) which are hardwired and still active even with a remote connected.

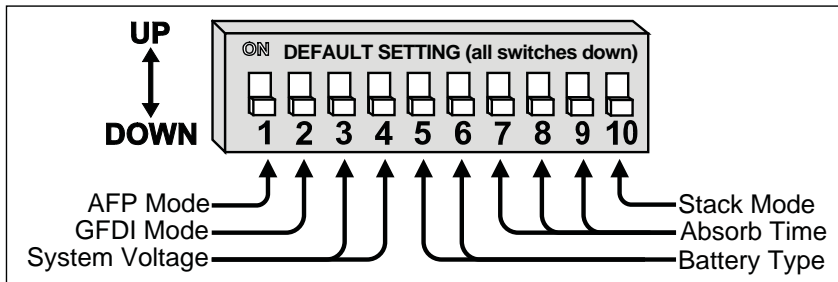
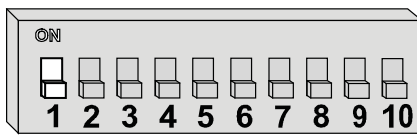

**Figure 3-1,
 DIP Switch
 Summary**

Switch 1: AFP (Arc-Fault Protection) Mode

Normally this switch is DOWN, which enables the Arc-Fault Detection circuitry. This switch can be set to UP, which disables the Arc Fault Detection circuit to prevent nuisance tripping. See Section 4.6 for more information on the operation of the Arc-Fault Detection circuitry.

Arc-Fault
 detection
 enabled
 (DOWN)



Arc-Fault
 detection
 disabled
 (UP)

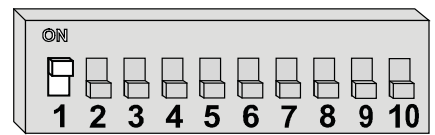

Switch 2: GFDI (Ground Fault Detection and Interruption) Mode

Normally this switch is DOWN (GFDI Enabled). The internal GFDI can be disabled to allow an external GFDI circuit to be used, the controller to operate with an ungrounded PV array, the battery negative to be grounded elsewhere in the system, or multiple controllers to be used in the same PV installation. See Section 4.5 for more information on the operation of the GFDI circuitry.

GFDI
 enabled
 (DOWN)

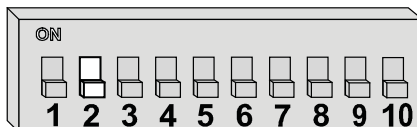

GFDI
 disabled
 (UP)

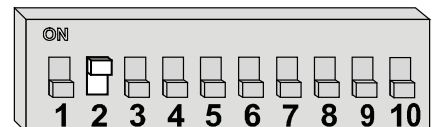

Switches 3 & 4: System's Battery Voltage

Four (4) settings are available for your system's nominal battery voltage as shown below. Use the auto voltage detection setting (default) to determine the system voltage automatically when the battery is connected to the PT controller; or, if the battery is out of its nominal voltage range (i.e., highly discharged), select the setting that matches the system's nominal battery voltage.

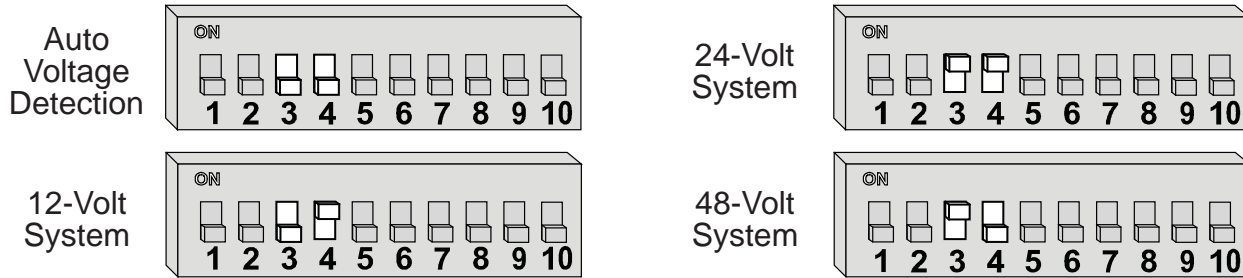

Switches 5 & 6: Battery Type

Switches 5 and 6 are used to select the battery type, which determines the battery charge profile and ensures the batteries are receiving the proper charge voltage. Select the battery type that matches your system's battery bank chemistry, or refer to Table 3-1 to determine the specific charge voltage to use based on the battery type selected.



Info: The voltages shown in Table 3-1 are based on the Battery Temperature Sensor (BTS) being disconnected, or at a temperature of 77°F (25°C). If the BTS is connected, the charge voltage changes based on the temperature around the BTS—to ensure the batteries receive the correct charge voltage even if they become cold or hot (see Section 4.7).

Table 3-1, Battery Type to Charge Voltages

Battery Type	System Voltage	Absorption Voltage	Float Voltage	Equalization Voltage	Equalization Time
Flooded	12 VDC	14.6 VDC	13.4 VDC	15.5 VDC	4.0 Hours
	24 VDC	29.2 VDC	26.8 VDC	31.0 VDC	
	48 VDC	58.4 VDC	53.6 VDC	62.0 VDC	
AGM 1 ¹	12 VDC	14.3 VDC	13.1 VDC	15.5 VDC	4.0 Hours
	24 VDC	28.6 VDC	26.2 VDC	31.0 VDC	
	48 VDC	57.2 VDC	52.4 VDC	62.0 VDC	
AGM 2 ²	12 VDC	14.5 VDC	13.5 VDC	Not Allowed	Not Applicable
	24 VDC	29.0 VDC	27.0 VDC		
	48 VDC	58.0 VDC	54.0 VDC		
GEL	12 VDC	14.1 VDC	13.6 VDC	Not Allowed	Not Applicable
	24 VDC	28.2 VDC	27.2 VDC		
	48 VDC	56.4 VDC	54.4 VDC		

Note 1: Specifications for Concord (Lifeline Series) AGM batteries.

Note 2: Specifications for East Penn, Deka, Discover and Trojan AGM batteries.

Switches 7, 8 & 9:

DIP switches 7, 8, and 9 determine the absorption charge time of the PT controller, unless the PT controller is networked (i.e., connected to a Magnum inverter and remote). Once the PT controller is networked, the absorption time is now determined by the remote; and DIP switches 7, 8, and 9 are no longer used.

Absorption Charge Time

When the PT-100 controller is NOT networked, eight (8) time periods are provided to determine how long the controller is in the Absorption Charge stage—holding the batteries at the Absorb Voltage setting.

The Auto Time Detection setting (switches 7, 8, and 9 are all set to the DOWN position) uses an absorption time that is equal to the time it takes the batteries to reach the Absorb Voltage setting while in the Bulk Charge stage. So if the battery is heavily discharged and it takes a long time to reach the absorb voltage, the same time will be used to keep the batteries in the Absorption Charge stage. The other seven (7) DIP switch settings can be used to provide a known/fixed absorption time period (1 hour to 7 hours).



Switch 10: Stack Mode (Future Feature)

Switch 10 is normally set DOWN (Factory default setting). This switch is provided to allow the multi-controller stacking feature to be enabled in the future. Stacking is currently not supported in this version.

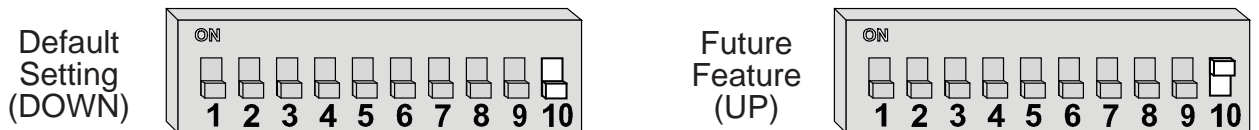

4.0 Operation

This section explains how the controller operates, and also provides information on the LED indicators and the digital display that are used to show the operational status of the PT controller.

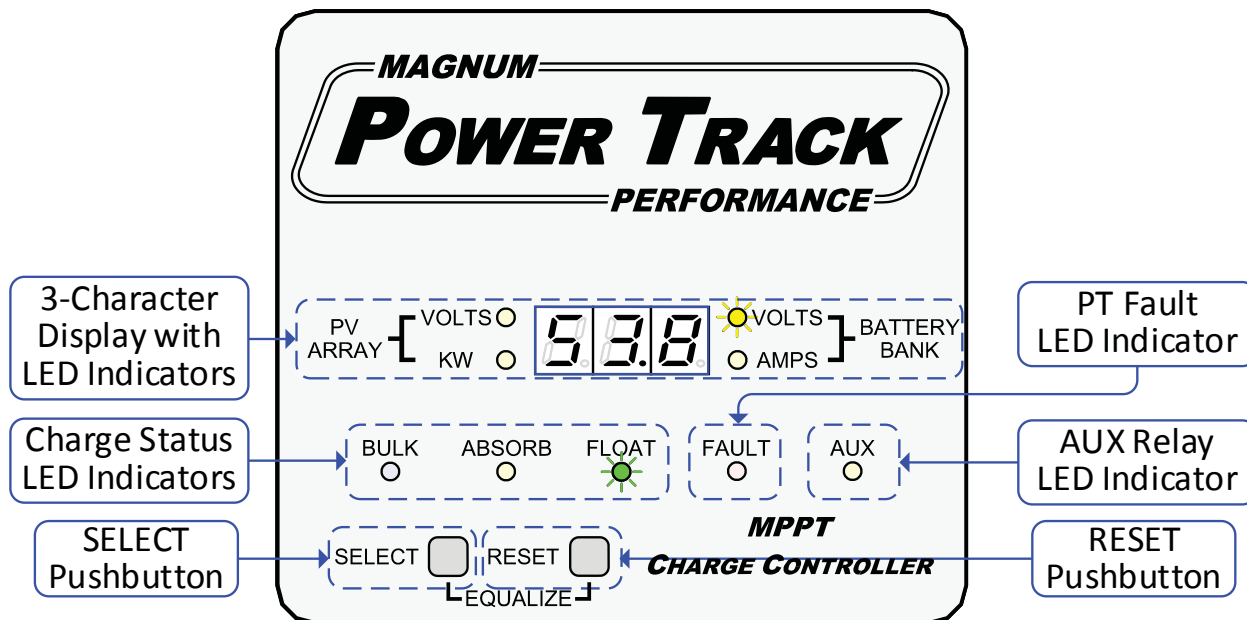

Figure 4-1, Front Panel Display and LED Indicators

4.1 PT Front Panel Features

The front panel is used to monitor and control the performance of the PT controller. As shown in Figure 4-1, it is comprised of the following features:

- **Display with LED Indicators** – The 3-character display with its four relevant LED indicators provide the controller’s operational information. The following screens are displayed in sequence:
 - PV ARRAY VOLTS (and LED) • PV ARRAY KW (and LED) • BATTERY BANK VOLTS (and LED)
 - BATTERY BANK AMPS (and LED) • Power Status Code¹
- **Charge Status LED Indicators** – The at-a-glance LEDs identify the charging stage the controller is in [BULK (blue), ABSORB (yellow), FLOAT (green), or EQUALIZE (all 3 charge LEDs on)].
- **Fault LED Indicator** – the Fault LED (red) illuminates to indicate when a fault condition exists. When the FAULT LED comes on, the display also shows the F## fault code used to determine the fault condition. For details about fault codes, see Section 5.3, *Troubleshooting Based on Fault Codes*.
- **Aux (Auxiliary) Relay LED Indicator** – The AUX LED (yellow) illuminates when the auxiliary relay is energized.
- **SELECT Pushbutton** – This pushbutton allows the display to stop or resume automatic scrolling, to quickly advance thru the operational screens while the display is auto-scrolling, or to allow you to manually scroll thru the screens when the display is not auto-scrolling. This pushbutton can also enable an equalization charge when pressed with the RESET pushbutton.
- **RESET Pushbutton** – This pushbutton allows you to clear a fault, and to enable an equalization charge when pressed with the SELECT pushbutton.

Note 1: The Power Status Code shows each time when manually scrolling through the screens. It also shows when the display is during auto-scrolling and the output power is being limited. For details about power codes, see Section 4.2.3, Power Status Codes.

4.2 Front Panel Operation

When power is applied, the display on the PT controller goes through a power-up test routine (see Figure 2-27). Once the power-up test is complete and no faults occur, the controller begins operating and the display begins automatically scrolling through the operational displays (see Figure 4-2).

4.2.1 Operational Displays

The operational displays provide information on the PV voltage and power, the battery voltage and current, the power status, and any fault condition that may occur. Each operational display is shown in a particular sequence; after all the displays are shown, the sequence starts again.

Unless there is a fault, the display automatically scrolls continuously through each operational screen. If a fault occurs, the display stops scrolling and shows the fault display. Once the fault condition is acknowledged (by quickly pressing the SELECT pushbutton), the display begins auto-scrolling again. After the auto-scrolling continues, the fault screen and the first four operational screens are shown.

The display can be stopped from auto-scrolling by pressing the SELECT pushbutton for one second. Once the display is no longer auto-scrolling, you will need to quickly press and release the SELECT pushbutton to manually scroll through each operational display. While manually scrolling thru the displays, the Power Status code (which may not have shown while auto-scrolling) will always show after the first four operational displays—along with the fault display if active.



Info: If the display is auto-scrolling, the Power Status code will only show if the controller's output power is being limited (P03, P04 or P05). Otherwise, only the first four operational displays will be seen—along with the fault display if active and acknowledged.



Info: If the display is not automatically scrolling, the SELECT pushbutton can be pressed for 1 second to allow the display to resume auto-scrolling.

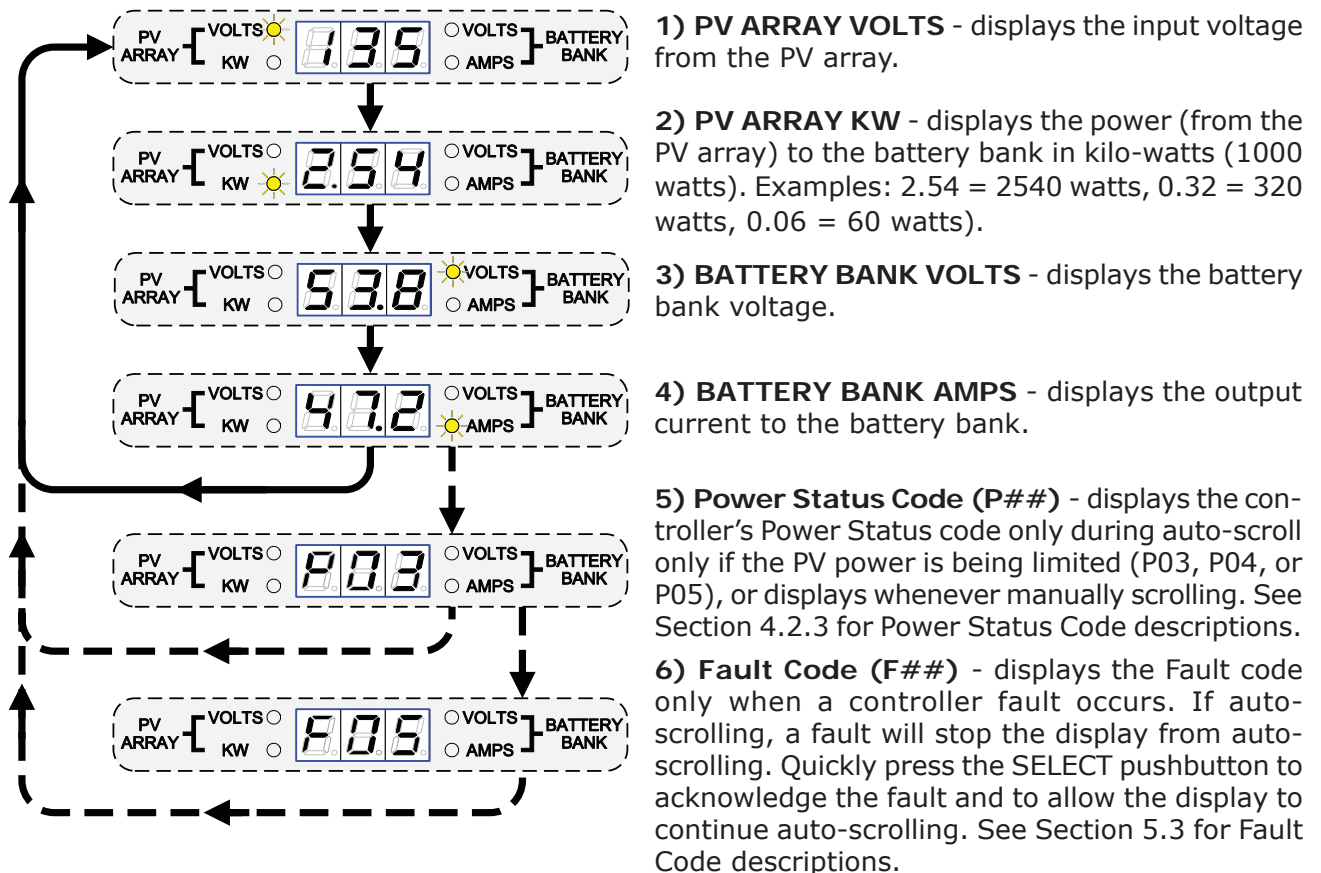

Figure 4-2, Scroll Sequence of Screens

4.2.2 Charge Status Indicators

The charge status LED indicators on the front panel indicate the charge status of the controller. The table below describes the charge stage of the controller and the charger operation—depending on what the charge status LED’s are doing.

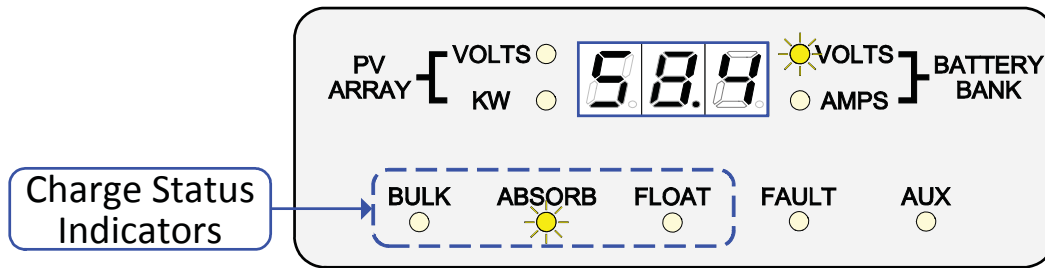

Figure 4-3, Charge Status Indicators

BULK (blue)	ABSORB (yellow)	FLOAT (green)	Description
OFF	OFF	OFF	Charging Off - the controller is either sleeping (nighttime), the PV is turned off, or there is a controller fault.
ON	OFF	OFF	Bulk charge stage - the controller is in the Bulk charge stage, providing maximum current from the PV to the battery.
Blink	OFF	OFF	Bulk charge stage (power limited¹) - the controller is in the Bulk charge stage, but current is being limited to the battery.
OFF	ON	OFF	Absorb charge stage - the controller is in the Absorb charge stage, regulating the current from the PV to maintain the battery at the Absorb target voltage ² .
OFF	Blink	OFF	Absorb charge stage (power limited¹) - the controller is in the Absorb charge stage, but current is being limited to the battery.
OFF	OFF	ON	Float charge stage - the controller is in the Float charge stage, regulating the current from the PV to maintain the battery at the Absorb target voltage ² .
OFF	OFF	Blink	Float charge stage (power limited¹) - the controller is in the Float charge stage, but current is being limited to the battery.
ON (1st - 2 sec)	ON (2nd - 2 sec)	ON (3rd - 2 sec)	Equalize charge stage - the controller is in the equalization charge mode, regulating the current from the PV to maintain the battery at the Equalize target voltage ² . <i>Note: Each charge status indicator is on for two seconds in sequence.</i>
Blink (1st - 2 sec)	Blink (2nd - 2 sec)	Blink (3rd - 2 sec)	Equalize charge stage (power limited¹) - the controller is in the battery equalization charge stage, current is being limited to the battery. <i>Note: Each charge status indicator blinks for two seconds, one after another in sequence.</i>

Note 1: Power Limited - When the controller is limiting power to the battery by backing off charging (from high temp, etc.), the active charge stage LED will blink every second. See Section 4.2.3 to view the Power Status Codes (P03 - P05), and to determine the reason for the limited power.

Note 2: Target Voltage - The temperature compensated voltage regulation setpoint. The battery will be regulated to the voltage setting determined by the active charge stage (i.e., Absorb, Float, or Equalize) and the Battery Type DIP switch setting; and includes any voltage increase or decrease based on the temperature around the BTS.





4.2.3 Power Status Codes

The digital display shows a P-number (P##) to indicate the status of the PV power delivered to the battery—through the controller. Table 4-2 lists each Power Status Code and its description.



Info: If the display is auto-scrolling, the power status only shows if the power output is being limited (P03 - P05), otherwise only the first four operational displays will be seen. If you are manually scrolling thru the display (by pressing the SELECT pushbutton), the power status will always show after scrolling through the first four operational displays.

Table 4-2, Power Status Code Descriptions

	<p>Power Maximized (MPPT is On) - the MPPT circuit in the PT controller is delivering the maximum power from the array to the battery—there is no voltage or current regulation occurring.</p>
	<p>No Power Output - this PT controller has been turned off, is sleeping (during night-time), or a shutdown fault has occurred.</p>
	<p>Battery Voltage Regulation (Normal current regulation) - the PT controller is regulating the current to keep the batteries at their target voltage, either in the Absorb, Float, or Equalization charge stage.</p>
	<p>Battery Current Regulation (Normal current regulation) - the PT controller is regulating the output current to ensure the controller’s maximum output current to the battery bank is not exceeded.</p> <p> Info: The output current may be limited by the maximum charge rate setting in the remote—if networked.</p>
	<p>Power Limited (Internal High Temperature) - the temperature inside the PT controller is high, the P03 power code will show if the output current is being limited in an attempt to prevent the controller from shutting down.</p> <p><i>Note: The active charge status LED indicator will blink during this power status.</i></p>
	<p>Power Limited (Internal Frequency) - the controller includes a variable frequency converter, the P04 power code will show if the output current is being dialed back to prevent the frequency from going too high or too low.</p> <p><i>Note: The active charge status LED indicator will blink during this power status.</i></p> <p> Info: The P04 power code can be triggered by sizing the PV array’s VOC too close to the battery voltage. If P04 is seen often, the array wiring may need to change to increase the PV voltage input.</p>
	<p>Power Limited (Above Voltage Regulation) - the battery voltage is above the target voltage setpoint. Generally, this is due to an external charger charging the battery at a higher voltage level. The P05 power code will show when the PT controller is limiting the output current in an attempt to prevent the battery voltage from increasing to a voltage level that would trigger a ‘High Battery Input’ (F04) fault.</p> <p><i>Note: The active charge status LED indicator will blink during this power status.</i></p>

4.2.4 Fault Indicator

Whenever a fault condition occurs, the red FAULT indicator illuminates (comes on or blinks) and a fault code (F##) is displayed.

Info: If a fault code (F##) is displayed, refer to Section 5.3 to determine and troubleshoot the fault condition.

Hard Faults - If the fault condition causes the controller to shut down, the fault indicator will be on solid (see Figure 4-4). These are referred to as hard faults (F01 - F04, F06 - F09, F11 - F16).

Info: If the display is auto-scrolling and a fault condition occurs, the display will stop the auto-scroll and display the fault code. If you do a quick press and release of the SELECT pushbutton to acknowledge the fault has occurred, the display will resume automatically scrolling—showing the fault display in sequence with the other operational displays.

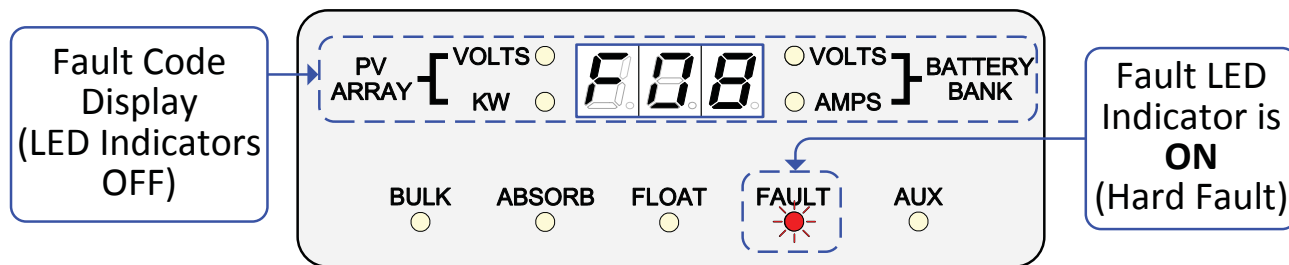

Figure 4-4, Hard Fault Conditions

Soft Faults - Some fault conditions will not cause the controller to shut down. With these particular faults, the fault indicator will blink (see Figure 4-5). These are referred to as soft faults (F05, F10).

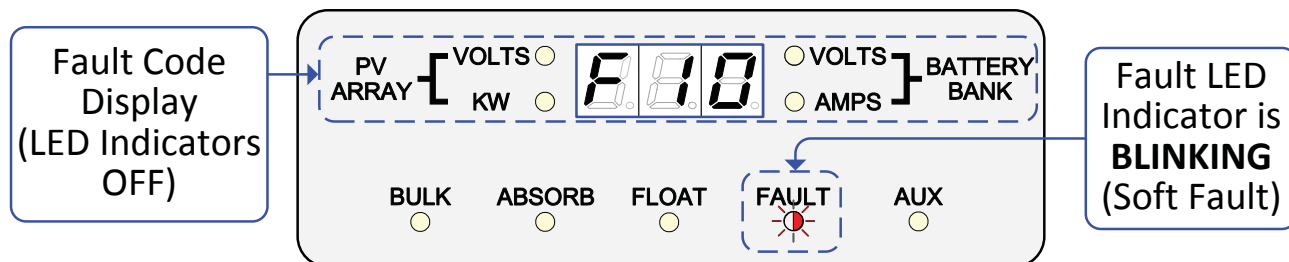

Figure 4-5, Soft Fault Conditions

4.2.5 Aux Relay Indicator

Whenever the internal auxiliary relay engages/energizes, the yellow AUX LED indicator comes on. As a standalone controller, this relay closes the COM to N.O. terminals (and opens the COM to N.C. terminals) anytime the PT controller has a fault condition. If the PT controller is networked, refer to the relay status in the remote control to determine the reason the relay has engaged.

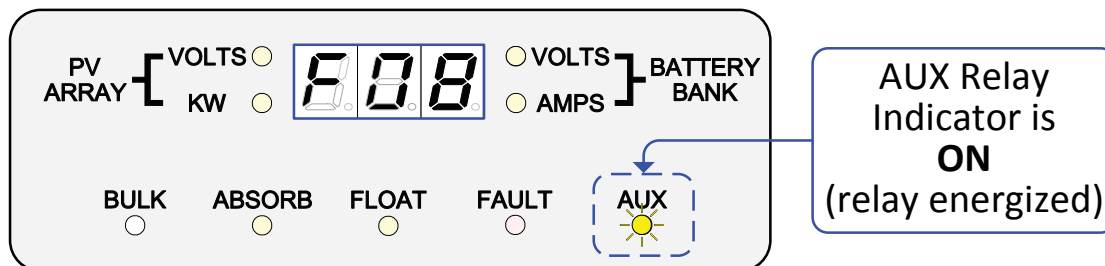

Figure 4-6, Aux Relay indicator

4.2.6 Display/LED Indicator Summary

- PV VOLTS (yellow) is ON = displays the input voltage from the PV array.
- PV KW (yellow) is ON = displays the PV array power (in kilo-watts) to the battery bank.
- Battery VOLTS (yellow) is ON = displays the voltage of the battery bank.
- Battery AMPS (yellow) is ON = displays the current going into the battery bank.
- BULK (blue) is ON = the controller is in the Bulk charge mode.
- ABSORB (yellow) is ON = the controller is in the Absorption charge mode.
- FLOAT (green) is ON = the controller is in the Float charge mode.
- FAULT (red) is ON = the controller has an active fault (view F## fault code on display).
- AUX (yellow) is ON = the auxiliary relay is energized.
- BULK, ABSORB or FLOAT (*the active charge stage*) is double-blinking ON every second = controller is limiting power to the battery by backing off charging (from high temp, etc.,).
- BULK (blue), ABSORB (yellow) then FLOAT (green) are ON every second in order = controller is in the Equalize charge mode.
- Display and the four LED's around the display are off (except the decimal point/period in each segment of the display comes on in sequence) = Powersave mode is enabled in the controller. Comes out of Powersave mode with an active fault or any button is pushed and returns to Powersave mode if no fault occurs, or no button is pushed for 15 minutes.

4.2.7 SELECT and RESET Pushbuttons

SELECT - This pushbutton allows you to quickly scroll through the operational screens, and is also used to stop or resume the digital display from auto-scrolling. Normally, the digital display automatically scrolls through the operational screens. Press this pushbutton for two seconds to stop the automatic scrolling. Once the automatic scrolling has stopped, quickly pressing and releasing the SELECT pushbutton allows you to advance to the next screen in sequence. To restart the auto-scrolling of the screens, press this button again for two seconds.

RESET - This pushbutton is used to clear any active fault. Most faults can be cleared by pressing the RESET pushbutton for one second (Fault Code F14 takes 10 seconds). See Section 5.3, Troubleshooting Based on Fault Codes for specific information on clearing and troubleshooting fault codes.



Info: Pressing the SELECT and RESET pushbuttons at the same time for two seconds enables the equalization charge—if allowed based on the Battery Type DIP switch setting (see Table 3-1). Once an equalization charge has been enabled, it will run for the equalization time (see Table 3-1), or you can press the SELECT and RESET pushbutton at the same time again for two seconds to stop the equalization charge stage.



Info: The RESET pushbutton is also used to perform a controller reset (also known as a soft reset), press and hold the RESET pushbutton for approximately ten (10) seconds until the PT controller begins the power-up test routine. During this power-up test, all the LED indicators and each segment of the display will come on, the internal alarm beeps three times, and right before the power-up test finishes, the PT firmware revision and the nominal DC detected voltage is displayed (see Figure 2-27).



Info: You can check the pushbutton response by pressing the SELECT or RESET pushbutton and listening for a beep after an active function (e.g., manual scrolling).

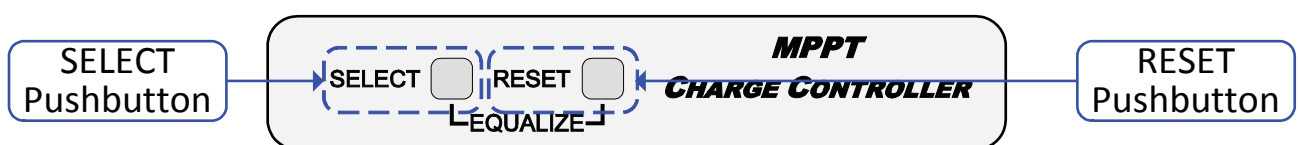

Figure 4-7, SELECT and RESET Pushbuttons

4.3 MPPT Operation

The PT-100 charge controller uses an electronic technique known as Maximum Power Point Tracking (MPPT) to harvest the maximum possible power from the PV array—under any environmental condition—and use this additional power as increased current available to charge the batteries.

The purpose of MPPT is find the point of the PV array’s operating curve (shown in Figure 4-8) where the current (I) and voltage (V) are optimized at the same time—referred to as the Maximum Power Point (MPP). The MMPT algorithm in the PT-100 is designed to sample the output of the PV array and adjust the load it presents to the PV array until the voltage and current approaches the MPP. The sampling is continuous in case the PV maximum output power changes because of environmental conditions, such as panel shading, cloud cover, and panel temperature.

Each morning when the PT controller awakes, a full sweep of the PV array is performed to find the maximum point. The high efficiency of the PT-100 to harvest the array’s maximum power is obtained based on its ability to closely operate at the MPP, its quick response to changes in the MPP, and the periodic full sweeps to guarantee that it continues to operate at the correct MPP.

When the charge current to the batteries is higher than required, or the batteries are close to being fully charged and are no longer able to absorb the incoming current, the controller can no longer operate the panel at its maximum power point. When this happens, the MPPT algorithm in the PT controller limits the charging current to the battery by moving the PV panel operating point away from the peak power point.

Night-time PV Array Disconnect

The PT controller includes an automatic night-time disconnect circuit. During night-time periods when the PV array voltage is lower than the battery voltage, the batteries are prevented from being discharged into the PV array by an internal switch. This internal switch disconnects the PV array from the batteries - eliminating the need for a blocking diode between the PV array and the battery.

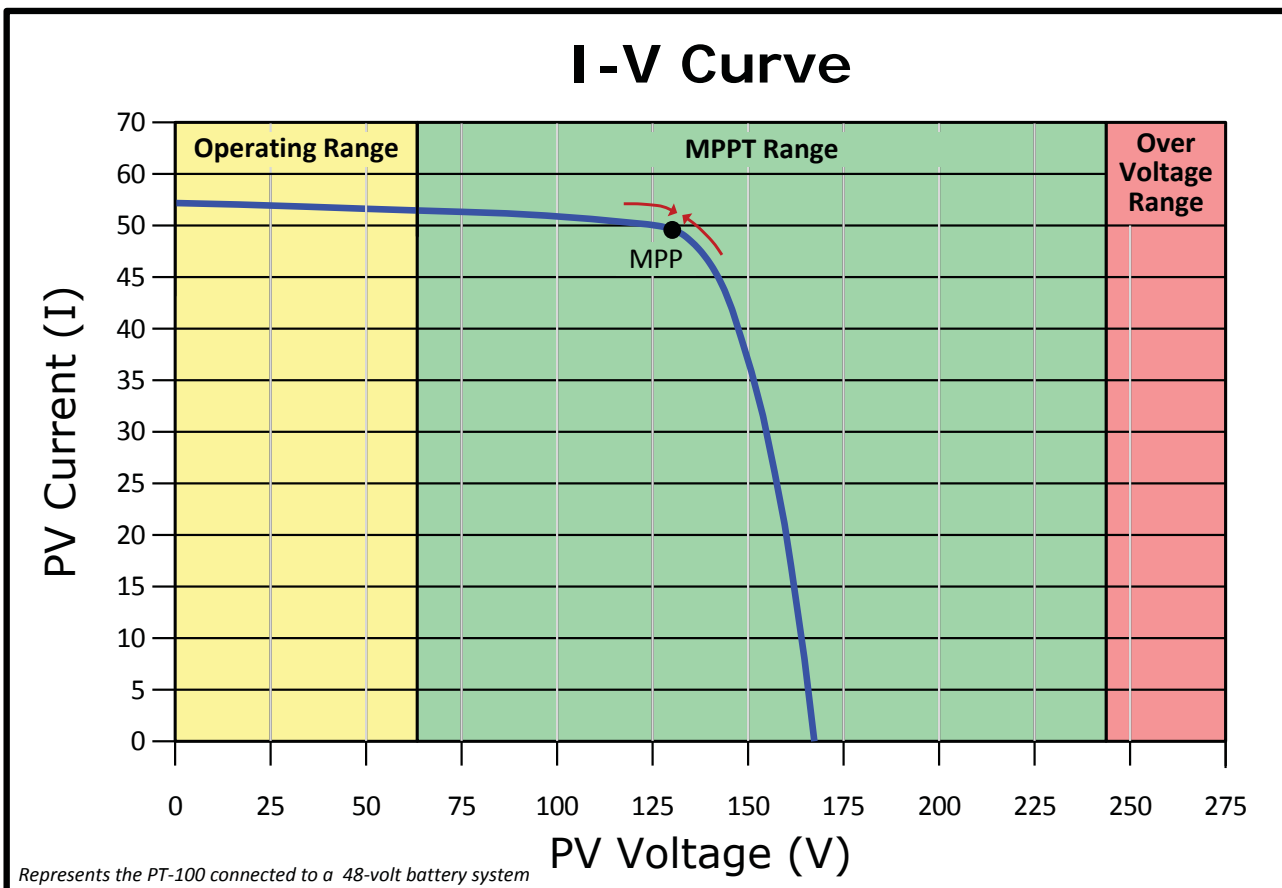

Figure 4-8, I-V Curve

4.4 Charger Control Operation

As a charge controller, the PT-100's primary function is to monitor and charge the batteries appropriately when PV power is available, and to prevent the batteries from being overcharged. When PV power is connected to the PV input, the charge controller begins monitoring for acceptable PV power and begins charging the batteries once it has accepted the PV input. The PT controller uses up to four different charging stages to help monitor and keep the batteries healthy. The four stages include an automatic 3-stage charging process: Bulk, Absorb, and Float (see Figure 4-9); and a manual Equalization (EQ) charge stage. The automatic 3-stage charge process provides complete recharging and monitoring of the batteries without damage due to overcharging. The EQ stage (requires a two pushbutton press to enable) is used to stir up stratified electrolyte and to reverse any battery plate sulfation that may have occurred.

Bulk Charging: This is the initial stage of charging. While bulk charging, the charger supplies the battery with controlled constant current (up to 100 amps). The charger will remain in bulk charge until the absorption charge voltage (determined by the Battery Type selection) is achieved. The BULK (blue) LED comes ON to indicate the PT controller is in the Bulk charge stage. The controller begins each new day (new day = 2 hours without sun) in the Bulk charge stage.

Absorb Charging: This is the second charging stage and begins after the absorb voltage has been reached. Absorb charging provides the batteries with a constant voltage (determined by the Battery Type setting) and reduces the charging current in order to maintain the Absorb Voltage setting. The controller's ABSORB (yellow) LED comes on to indicate it is in the Absorb charge stage for a time period (determined by the Absorb Time setting), then switches to float charging.



Info: While absorb charging, the timer inside the PT controller which is used to determine how long to stay in the Absorb charge stage, only counts when the battery voltage is at the Absorb Voltage setting. This means the PT controller will be in the Absorb charge mode longer than the Absorb Time setting if conditions prevent the PV array from producing enough power for the PT controller to maintain the batteries at the absorb voltage level.

Float Charging: The third charging stage occurs at the end of the absorb charge time. While float charging, the charge voltage is reduced to the float charge voltage (determined by the Battery Type setting). In this stage, the batteries are kept fully charged and ready if needed. The charge controller's FLOAT (green) LED comes on to indicate float charging. The Float charge stage reduces battery gassing, minimizes watering requirements (for flooded batteries), and ensures the batteries are maintained at optimum capacity. If the battery voltage falls ≤ 12.2 VDC (12-volt system), ≤ 24.4 VDC (24-volt system), or ≤ 48.8 VDC (48-volt system) the controller will re-initiate bulk charging.

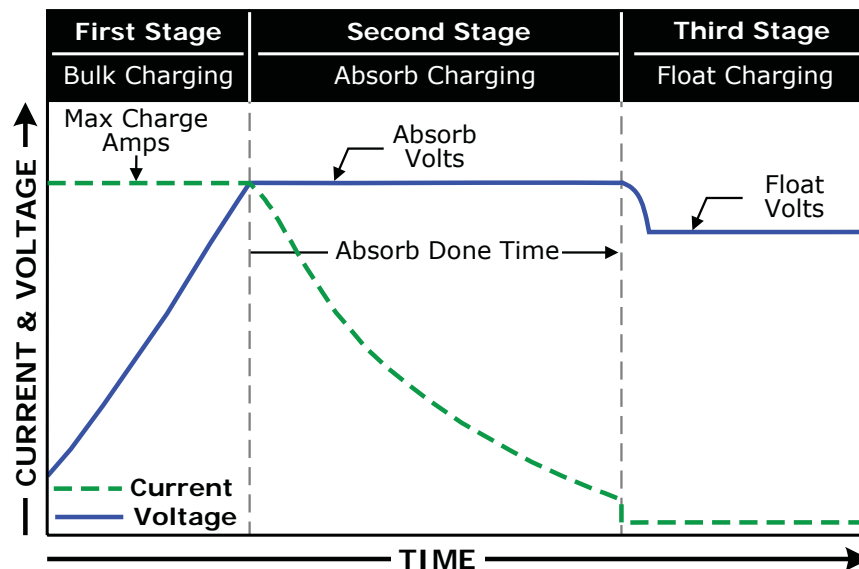

Figure 4-9, Automatic 3-Stage Charging Graph

4.4.1 Equalizing the Battery Bank

Equalizing (EQ) is a “controlled overcharge” of a lead-acid battery (or battery bank) done to help the battery reach and maintain peak capacity. This controlled overcharging helps equalize the chemistry in the individual battery cells by mixing the battery electrolyte (to reverse the buildup of stratification), and by removing lead sulfate that may have built up on the plates. These conditions if left unchecked, reduce the overall capacity of the battery.



WARNING: Do not perform an equalization charge without reading and following all safety precautions pertaining to charging/equalization. Carefully review all information in this manual and that provided by the battery manufacturer, and any equalization information for any other charger in the system (i.e., inverter owner’s manual).



WARNING: Equalizing produces hydrogen and oxygen gas. To avoid explosions, ensure the battery compartment has adequate ventilation in order to dissipate this gas.



CAUTION: Precautions and Guidelines when Equalize Charging

- If any DC Loads are connected to the battery bank, ensure they will not be damaged by the higher voltage applied to the batteries during the equalize charge. If in doubt, disconnect the loads to prevent damage.
- Ensure your batteries can be equalized. Only do so if permitted by your battery manufacturer or dealer. Performing an equalization charge on batteries other than liquid lead acid or certain AGM types could permanently damage them.
- Check all batteries before and after equalization and make sure the electrolyte is at the correct level. During the equalize charge, the batteries will begin gassing and bubbling vigorously, which consumes water. So prior to equalizing, ensure each cell has adequate distilled water, but do not overfill because the electrolyte may expand and overflow. Once the equalization charge cycle has finished, add water as needed to ensure the plates are covered.
- Refer to your battery manufacturer to either leave the filler caps screwed on (if vented), leave them on loosely, or remove them and cover the opened cell tops with a folded paper towel.
- Only equalize when you are present to monitor the batteries during the entire charging cycle.

How often should I equalize charge? Some experts recommend to equalize batteries every thirty days when they are cycled daily, or every thirty deep cycles. Other experts only recommend equalizing when the battery capacity has decreased (i.e., not holding loads as well now as they did previously), the cells have a low specific gravity, or when the difference between any individual cell has a specific gravity reading greater than .015 after being fully charged. Contact your battery manufacturer for their recommendations.

How long should I equalize charge? While the batteries are gassing, monitor the specific gravity readings every hour. When the specific gravity readings no longer increase, the equalization charge is complete and should be stopped manually. If you do not stop the equalization process manually, the EQ cycle ends automatically after the EQ time is complete and goes into the Float charge mode (FLOAT LED comes on).



Info: When configured as a standalone device, and Flooded or AGM 1 is selected as the Battery Type, the EQ time is 4 hours at the EQ voltage. However, the PT controller will be in the EQ charge mode longer than four hours if conditions prevent the PV array from producing enough power for the PT controller to maintain the batteries at the EQ voltage level.



Info: Equalization charging time: a) Counts when EQ is enabled and the battery voltage is close to the EQ Volts setting ($\leq 0.1v/12$ -volt systems, $\leq 0.2v/24$ -volt systems, or $\leq 0.4v/48$ -volt systems); b) Pauses when controller is turned off (using a remote); c) Clears when EQ charge mode time is completed, the controller is forced into Bulk/Absorb or Float (using a remote), or the EQ charge mode is manually stopped.

4.4.2 Starting or Stopping an Equalization Charge Cycle

See Table 3-1 to determine the equalize voltage for your battery type. Equalize charging can only be enabled if the *Battery Type* setting allows.



Info: Equalization charging is available if *FLOODED* or *AGM 1* is selected as the Battery Type (DIP switches 5 and 6), it is not available if *GEL* or *AGM 2* is selected.

To start the equalization charge cycle:

1. Make sure PV power is available to the controller, and the controller is charging the batteries (i.e., BULK, ABSORB or FLOAT LED is on).



Info: If there is not enough PV power available to allow the controller to start charging, the equalization charge cycle can not be enabled from the front panel.

2. Press the SELECT and RESET pushbuttons simultaneously until the BULK, ABSORB, and FLOAT LEDs come on in sequence (~2 seconds). These LEDs continue to come on in sequence throughout the equalization charge cycle.

To stop an equalization charge cycle manually, press the SELECT and RESET pushbuttons simultaneously until the BULK, ABSORB, and FLOAT LEDs no longer come on in sequence (~2 seconds). Once EQ has stopped, the PT controller returns to the charge stage it was in before EQ was started. The EQ charge will also stop if PV voltage to the controller is interrupted; if this happens, the controller will return to the previous charge stage once PV voltage is reconnected.

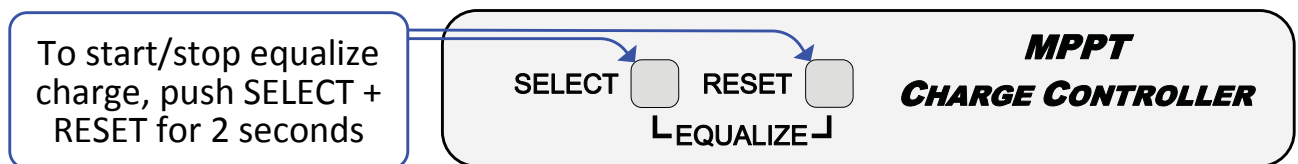

Figure 4-10, Start/Stop Equalize Charge

4.5 Ground Fault Detection and Interruption (GFDI) Operation

The GFDI circuit inside the PT controller has the ability to detect, indicate and interrupt a ground fault in the PV array, which may be required according to the National Electrical Code 690.5.

If the PV array is wired in a negative grounded configuration, the internal 0.5 amp GFDI fuse should provide the PV system's only negative-to-ground bond and is used to detect PV ground-faults. If a ground fault current larger than 0.5 A is detected, the GFDI fuse will open, the PT controller will turn off, and the display will indicate the F12 (Ground Fault) code. After the ground fault has been located and eliminated and the GFDI fuse replaced, the ground fault code must be cleared (by pressing the RESET pushbutton for one second) before the controller resumes operation.

The Ground Fault Detection circuit can also be disabled by setting the GFDI switch (DIP switch #2) to UP. Disabling the GFDI allows the controller to operate with an ungrounded PV array, allows a single negative-ground connection to be made elsewhere in the system (so that an external GFDI circuit can be used), and allows multiple controllers to be used in the same PV installation.

If the PT controller's internal GFDI circuit is required to be disabled, the GFDI fuse must also be removed. Removing the GFDI fuse opens the negative-to-ground bond within the controller so that a single negative-ground connection can be made elsewhere in the system—either at the battery terminal or through an external PV-GFDI circuit connected to the PV wiring. To remove or replace the GFDI fuse, see Section 5.5.

4.6 Arc-Fault Protection Operation

Arcs are caused by an intermittent connection and are dangerous because they are not an overload or short-circuit, so the overcurrent protective device does not operate; however, they can burn through wiring insulation or ignite nearby combustibles.

The PT controller has an integrated Arc-Fault Protection (AFP) circuit, which provides additional protection against fires caused by an arc in the PV system. Arc-fault protection is required according to the National Electrical Code (NEC) for PV systems operating at a maximum voltage of 80 volts or greater. In accordance with Section 690.11 of the NEC, the AFP circuit should detect, indicate and interrupt an arc-fault, and the fault indication should not be able to automatically reset/clear. After a series arc-fault is detected, the PT controller shuts down and displays a F13 (AFP Fault) code. Once the PT controller shuts down, the circuit is opened in an attempt to extinguish the arc-fault in the PV system. When the PT controller has shut down from detecting an arc-fault, it must be manually reset.

What is a series arc-fault? A “series” arc-fault results when the intended continuity of a current-carrying conductor, connection, or component in series with the load is failing. This is different from a “parallel” (or short-circuit) arc-fault, which is a short between two current-carrying conductors, or between a current-carrying conductor and a grounding conductor or other grounded device.

Series arc-faults occur when the PV array is producing current and a connection in the PV electrical circuit becomes more resistive (i.e., unintentionally starts opening). This can be caused by damaged conductors, or loose/corroded connections (either inside a PV module or on a PV system component).

4.6.1 AFP Test Switch

The arc-fault test switch (see Figure 4-11) is provided to determine whether the arc-fault detection circuit in the PT controller is functioning properly. When the arc-fault test button switch is pressed and released, a simulated arcing condition is generated and the AFP circuit must be able to detect this arcing condition and cause the PT controller to shut down.

To perform an arc-fault protection circuit test:

1. First ensure the PT controller is on and operating, and PV power is available and connected to the PT controller’s PV input.
2. Quickly press and release the arc-fault test button switch.



Info: The arc-fault test switch is a small momentary type button switch which operates by lightly pressing and releasing. Be careful not to apply too much force when pushing or the switch might break.

3. The fault LED (red) comes on, F13 (AFP Fault) code displays, and the PT controller shuts down.
 4. The PT controller must not resume operation until the AFP fault is manually cleared (either by pressing the RESET pushbutton for one second, or removing all power from the PT controller).
- If all four steps passed, then the arc-fault circuit inside the PT controller is functioning properly.

If the AFP circuit test fails:

1. Ensure there is sufficient PV power connected to the PT controller’s input—this test cannot be performed unless there is sufficient PV current available to produce an arc.
2. Ensure the arc-fault detection circuitry is enabled by verifying DIP switch #1 is DOWN.

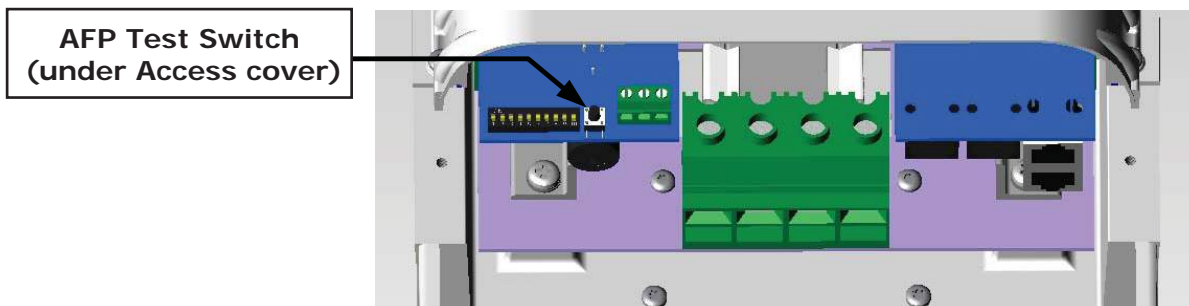

Figure 4-11, AFP Test Switch

4.7 Battery Temperature Sensor Operation

The plug-in Battery Temperature Sensor (BTS) is used to determine the battery's temperature. This information allows the multi-stage battery charger to automatically adjust the battery charge voltages for optimum charging performance and longer battery life.

With a BTS installed, the controller will adjust the bulk and float charge voltage according to the temperature around the BTS. If the temperature around the BTS is below 77°F (25°C) the absorb and float charge voltage increases, and if the temperature around the BTS is higher than 77°F (25°C), the absorb and float charge voltage decreases. See Figure 4-12 to determine how much the charge voltage changes (increases or decreases) depending on the temperature reading of the BTS. For example, if the nominal absorb charge voltage on a 24-volt model is 29.2 VDC at 77°F (25°C); if the battery temperature increased to 95°F (35°C), the absorb charge voltage would decrease to 28.6 VDC (29.2 VDC) a - 0.6 VDC change.

If the temperature sensor is NOT installed, the PT controller only charges at a temperature of 77°F (25°C). This may reduce the life of the batteries if they are subjected to large temperature changes.



Info: When the BTS is connected, the PT controller uses a value of -5mV/°C/Cell from -20°C to +54°C to change the charge voltage based on temperature.



Info: If the BTS cable is damaged and the wires are shorted, the display will indicate a F05 (BTS Shorted Fault) message. If the BTS has been connected, and later the cable has been cut or is disconnected, the controller displays a F16 (BTS Open Fault) message to alerts the user that the BTS has been disconnected. In either situation, the PT controller will no longer automatically adjust the charge voltage level based on temperature changes, but will maintain the charge voltage level based on a temperature of 77°F (25°C).



Info: When a PT controller is networked to a Magnum inverter that has a BTS connected, the inverter's BTS is used to determine the PT controller's temperature compensation.

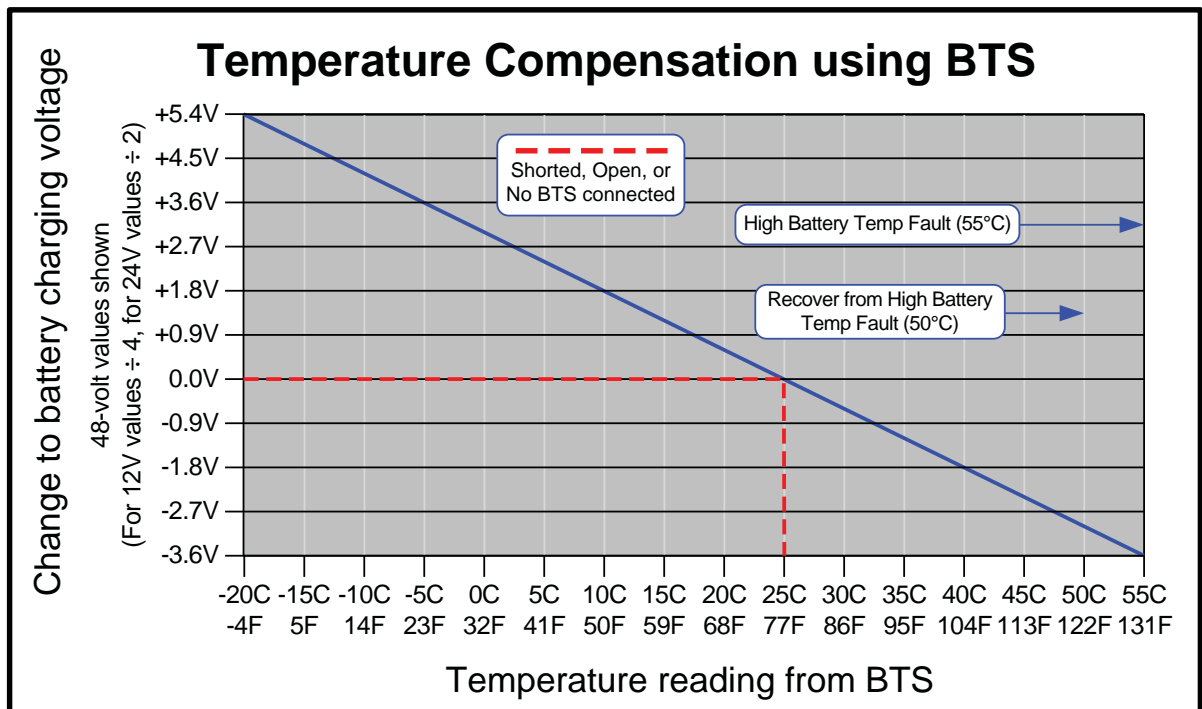

Figure 4-12, BTS Temperature to Charge Voltage Change

4.8 Charge Controller Fan Operation

The charge controller contains two internal cooling fans that are automatically controlled. When the fans turn on or turn off is determined by the temperature of certain components inside the charge controller. The charge controller’s fans will come on under the conditions listed below.

Fans run full speed if any of the following abnormal conditions are met:

- the internal transistors (FETs) reach $\geq 70^{\circ}\text{C}$ (158°F), or
- the internal inductor $\geq 90^{\circ}\text{C}$ (194°F), or
- the ambient temperature inside the controller $\geq 60^{\circ}\text{C}$ (140°F).

Once the fans turn on, they continue to run until all of the following conditions are met:

- the internal transistors (FETs) reach $< 60^{\circ}\text{C}$ (140°F), and
- the internal inductor $< 85^{\circ}\text{C}$ (185°F), and
- the ambient temperature inside the controller $< 55^{\circ}\text{C}$ (131°F).

The fans also shut down when the controller is off (PV input power is disconnected or at nighttime), during a F14 fault (Internal NTC Fault), or a very high destructive temperature on the FETs or inductor occurs.

Info: Whenever the charge controller is first connected to the battery, the fans start and run for about 1 second.

Info: The temperature sensed by the BTS does not determine whether the charge controller’s fans start or stop.

Info: The PT-100 delivers full output current (100 amps) in ambient temperatures up to 40°C (104°F). Due to the fan cooling, this level of performance can be achieved in closed rooms. The PT-100 does remain operational above 40°C (104°F), but the charger output level is reduced to protect the internal components from overheating (see Figure A-1).

4.9 PowerSave Operation

To reduce unnecessary power consumption, the front display and the four LED’s around the display automatically go into PowerSave mode - if there is no fault or button push for 15 minutes. While in PowerSave mode, the four LED’s around the display turn off and the display turns off except for the decimal point/period in each segment of the display comes on in sequence (from left to right, then right to left). This is to give some indication that the PT is still powered and working.

The controller immediately comes out of PowerSave mode when an active fault occurs or the user pushes either of the two buttons (SELECT or RESET) on the front display of the controller.

Info: During PowerSave, the charge mode LED’s and AUX LED operate normally and come on if required. If there is a fault during PowerSave, the display and Fault LED will come on and stay on as long as the fault is active.

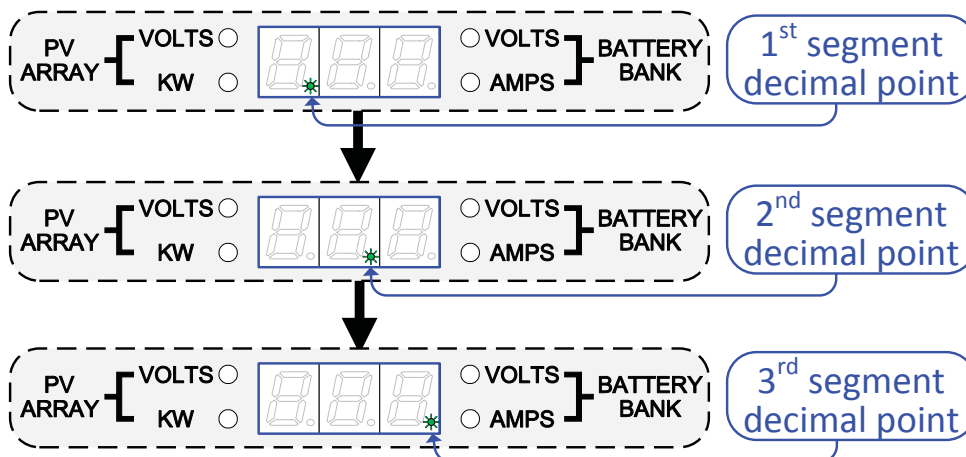

Figure 4-13, Power Save Indication

4.10 Auxiliary Relay Operation

When the PT controller is configured as a standalone device (i.e., not networked with a Magnum inverter/remote), the internal aux relay stays disengaged during normal operation, but engages when a PT controller fault is detected.

If the PT controller is networked (i.e., connected to a Magnum inverter and remote), the aux relay can be programmed to manually open or close, work as an automatic voltage-controlled relay (opens or closes based on VDC and activates either as an active high or active low type relay with an adjustable time delay), or used as an automatic fault detection relay (engages if a controller fault occurs).



Info: This auxiliary relay has three contacts, N.O. (Normally Open), COM (COMmon), and N.C. (Normally Closed). This means this relay has two sides; COM to N.O. is one side, and COM to N.C. is the other side. Having two sides means either side can be open or closed at any time, so using the terms “open” or “close” doesn’t appropriately describe the relay status. When describing this relay’s contact status or operation, the terms “engage” and “disengage” are used. When the PT controller energizes the aux relay to “engage”, the COM to N.O. contacts close and the COM to N.C. contacts open. When the aux relay is no longer energized, the aux relay will “disengage”, causing the COM to N.O. contacts to open and the COM to N.C. contacts to close.



Info: The aux relay disengages if all power (PV and battery) to the controller is lost.



Info: If the aux relay is engaged, the AUX LED (yellow) turns on and remains on as long as the relay is engaged, even during PowerSave mode. Once the relay is no longer engaged (has disengaged), the LED will turn off.



Info: For information on configuring the aux relay for operation when networked, refer to the appropriate remote control manual—including the revision that provides the *PT Aux Relay* menu (see Section 2.10.3).

4.11 Internal Beeper Operation

The PT controller includes an internal beeper or buzzer that sounds after one of the pushbuttons on the front display (SELECT or RESET) is pushed and performs an active function¹.

If the PT controller is networked, the internal beeper can be set to act as an alarm and automatically turn on if a PT controller fault has occurred, or turn on and off based on high or low battery voltage. The ability to set a high or low voltage setting means the alarm can be configured to activate either as an “active high” or “active low” type alarm. For information on configuring the beeper for alarm operation, refer to the appropriate remote control manual - the revision that provides the *PT Aux Relay* menu (see Section 2.10.3).



Info: The beeper sounds three times when doing a power-up test (see Section 2.12.2).



Info: The beeper is located inside the controller and if its sound level is not loud enough, the aux relay in the controller can be wired with an external alarm; allowing the aux relay to turn on the alarm if a PT fault occurs or based on high or low battery voltage - if networked.

Note 1: An active function means something happens (or is occurring). An example of an active function is when a fault shows on the display, the action of pressing the RESET button for 1 second causes the fault to clear and the beeper to sound. On the other hand, if there is no fault indication and you press the RESET button for one second, nothing happens; therefore, this action is not performing any active function, so the beeper does not sound.

4.12 Operating Configuration - Standalone vs Networked

The operating configuration in the PT-100 controller uses default settings that are adequate for most installations (shown in Table 4-3 and described below). When the controller is configured as a standalone controller, the controller's internal DIP switch is used to adjust these settings. However, when configured as a networked controller, the optional remote control/display (with PT-100 menus) allows more adjustable settings and wider adjustable ranges. For information on these settings in the remote control, refer to the remote's owner manual.

Some of the adjustable operating parameters:

- **Battery Type:** Sets the type of batteries being used in the system. This information tells the charger what absorb, float and EQ (if allowed) voltage levels to use to charge the batteries; and the amount of time the batteries are held at the EQ voltage.
- **Absorption Done:** This setting allows the user to determine how long to charge the batteries in the Absorb charge stage. This can be based on time (default), amps returned to the batteries, or State of Charge (SOC).
- **Max Charge Rate:** This setting can be used to limit the amount of current that the charger can deliver to the batteries.
- **AUX Relay:** Sets the condition that causes the relay to engage, either from a controller fault or a battery voltage level.

Note: Using a networked remote control allows you to monitor and customize the operating parameters for your PT controller; such as viewing daily peak power levels, viewing power harvested, viewing fault history information for troubleshooting, viewing control charge stages, and much more.



Info: The controller uses the remote settings when networked, and continues using these settings even if the remote is disconnected¹. These settings are retained until all power (PV and battery) is removed, then the controller reverts back to using the DIP switch settings.

Table 4-3, Controller Settings (Standalone vs Networked)

Adjustable Settings	Standalone PT-100 (DIP Switch)	Networked PT-100 (Remote Control)
Absorb and Float Charge Voltages (under Battery Type)	Flooded (Absorb=14.6V, Float=13.4V) ²	Flooded (Absorb=14.6V, Float=13.4V) ²
	GEL (Absorb=14.1V, Float=13.6V)	GEL (Absorb=14.1V, Float=13.6V)
	AGM 1 (Absorb=14.3V, Float=13.1V)	AGM 1 (Absorb=14.3V, Float=13.1V)
	AGM 2 (Absorb=14.5V, Float=13.5V)	AGM 2 (Absorb=14.5V, Float=13.5V)
		CC/CV (Absorb/Float=12.0 to 16.6V)
		Custom (Absorb/Float=12.0 to 16.6V)
EQ Charge Voltages/Time (under Battery Type)	Flooded (EQ=15.5V @ 4 Hours) ²	Flooded (EQ=15.5V @ 4 Hours) ²
	AGM 1 (EQ=15.5V @ 4 Hours)	AGM 1 (EQ=15.5V @ 4 Hours)
		Custom (EQ=12.0 to 16.6V @ 0.1 to 25.5 Hours)
Absorb Done	Time: 1 to 7 Hours (2.0 Hrs) ²	Time: 0.1 to 25.5 Hours (2.0 Hrs) ²
		Amps: 0-250ADC ¹
		SOC: 50-100% ¹
Max Charge Rate	100 Amps	0 to 100 Amps
AUX Relay Engage	Controller Fault	Controller Fault ²
		Battery Voltage

Note 1: If the remote is disconnected, the remote's Absorb Done Time setting is used instead of the Absorb Done Amps/SOC settings.

Note 2: PT-100 default Setting

5.0 Maintenance and Troubleshooting

This section contains an overview of maintenance recommendations and troubleshooting information for the PT-100 controller.



WARNING: Performing service or maintenance on the controller can be life-threatening if done improperly. Service on the controller must only be performed by authorized personnel, these are qualified electricians and technicians who are familiar with PV system wiring and safety practices.



WARNING: Dangerous voltages can exist inside the controller. Disconnect all PV and battery circuits to the PT controller before performing any maintenance or service. The PT controller has internal capacitors that remain charged after disconnecting all external sources of power (i.e., PV and battery). Resistors inside the PT controller will remove this voltage within 2 minutes. Wait at least 2 minutes for these capacitors to discharge before servicing the unit.



Info: When disconnecting the PT controller, we recommend first disconnecting the PV array, then the batteries. If the PT controller is charging and the batteries are disconnected first, you will get a P05 (Power Limited - Above Voltage Regulation) status and may get a F03 (High PV Input) fault. This is normal and indicates the PV voltage increased due to the load (i.e., batteries) on the PT controller output being removed. Normal operation resumes when the battery is reconnected.

5.1 Periodic Maintenance

The PT-100 charge controller is designed to provide you with years of trouble-free service. The following information is provided to help you keep your PT-100 charge controller in optimum operational condition.

5.1.1 Recommended Charge Controller Care

Even though there are no user-serviceable parts, it is recommended that the following maintenance steps should be performed annually to ensure optimum performance of the PT-100 and PV system:

- Inspect and re-torque the wire connections on the charge controller's internal DC terminal block and ground busbar connections.
- Check that all communication cable connections are secure.
- Check all conductors for any cracks, breaks, or deterioration in the insulation/conduits.
- Check the ventilation intake screen and exhaust opening, remove any dust/debris that might have accumulated.

5.1.2 Recommended Battery Care

Batteries are an essential part of the controller/PV system, so they should be regularly and carefully maintained. It is recommended that every 6 months the following maintenance steps should be performed to extend their useful life.



WARNING: Prior to performing any checks, switch off any loads on the battery (i.e., inverter, DC loads, charge controller).

- Visually inspect the batteries for cracks, leaks, or swelling—replace if necessary.
- Batteries should be clean, dry, and free of electrolyte and corrosion residue. Use baking soda to clean and remove any electrolyte spills or buildups.
- Clean and tighten all battery terminals and connecting cables.
- Check and fill battery water levels (liquid lead acid batteries only).
- Check individual battery voltages (load test those that have a voltage difference of more than 0.3 VDC from each other)—replace if necessary.

5.2 Basic Troubleshooting

The PT-100 charge controller is a fairly simple device to troubleshoot. The following chart is designed to help you quickly pinpoint the most common charge controller failures. If a fault code (F##) is shown on the display, refer to section 5.3.

Table 5-1, Basic Controller Troubleshooting (Remote not available)











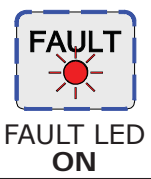

Symptom	Possible Cause	Recommended Solution
No display and all LEDs are off.	Battery voltage and PV voltage is too low.	Check battery voltage at the charge controller’s terminals. If sun is shining, check fuses/circuit-breakers and cable connections.
	Controller is in Powersave mode.	Normal operation - Press any front panel button to bring the controller out of PowerSave mode.
Low charging rate.	Display is showing P03, meaning the internal temperature of the charge controller is very high. The charge rate has decreased to prevent the controller from shutting down.	When the unit has cooled, the charge rate will automatically increase.
	Low PV input power.	Check for array shadows, overcast or low sunlight.
Batteries not charging.	Loose or corroded battery cables.	Clean and tighten battery cables.
	Defective batteries.	Replace batteries.
While charging, the DC charge voltage is higher or lower than expected.	If the Battery Temperature Sensor (BTS) is installed, the DC voltage will increase or decrease depending on the temperature around the BTS.	This is normal, see Section 4.7 (Battery Temperature Sensor Operation) for more information.

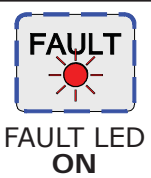



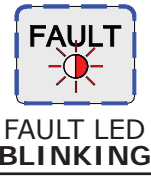

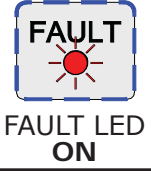



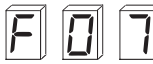



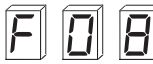

5.3 Troubleshooting Based on Fault Codes



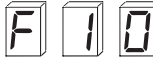



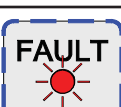



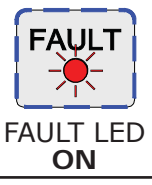



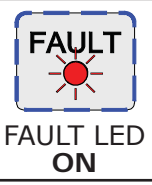

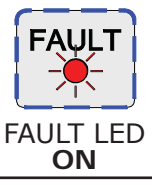
When the PT controller detects a fault condition, the FAULT LED turns on and a fault code number (F##) appears in the digital display to identify the problem. The following table describes each fault code and any suggested corrective actions to be taken for each code.

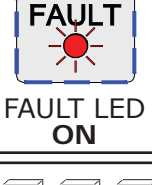
Table 5-2, Fault Code Descriptions

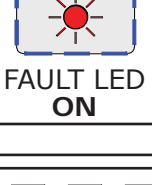
	<p>No PV Input Fault - the PT controller turned off because there has been no source of PV power detected on the PV input terminals ((i.e., PV+ to PV-) for more than 24 hours. This can be caused by an open breaker to the PV input, a bad PV wire connection to the PV input terminals on the PT controller, or a long period (>24 hours) of no sun or very low sun.</p> <p> Remedy: The fault will automatically clear and the controller will resume operation once the voltage to the PV input terminals is >5 volts above the battery voltage.</p> <p>This fault can also be cleared manually (for another 24 hours) by pressing the RESET button for one second.</p>
	<p>Internal Power Supply Fault - the PT controller turned off because the voltage from the auxiliary power supply in the controller has dropped to a low level. This can be caused by a load from the power circuit on the PT NETWORK or STACK port. This happens if an accessory cable that is plugged into the PT controller has shorted, or an accessory—that should be powered externally—is plugged into the PT and is attempting to be powered from one of the ports on the PT controller.</p> <p> Remedy: Remove any cable plugged into the NETWORK (or STACK) port and also check these two ports for debris; then, clear the fault by pressing the RESET pushbutton for one second. If the fault continues—after removing all cables, checking the ports for cleanliness, and pressing the RESET button— then the controller will require service.</p>

  <p>FAULT LED ON</p>	<p>High PV Input Fault - the PT controller turned off and stopped producing power to the batteries because a very high PV voltage (>187 VDC) has been detected on the PV input terminals (i.e., PV+ to PV-). This is usually caused during cold weather if the PV array voltage is sized too high or too close to the maximum PT input operating voltage. To prevent this fault and to keep the controller running, size the PV array to ensure the PV input stays below 188 volts under <u>any</u> weather condition. <i>Note: The PT operating range is VBat+5 VDC to 187 VDC. Some installers will size the array on purpose so that the Voc on a colder day may rise above 187 VDC, but never above the absolute max voltage (200 VDC + battery voltage or 240 VDC—whichever is lower). Most of the time if the battery needs to be charged and there is no other issue with the PT controller, the PT controller will MPPT and not let the voltage rise to the high turn off voltage level (e.g. >187 VDC).</i></p> <ul style="list-style-type: none">  Remedy: The fault will automatically clear and the PT controller will resume operation once the voltage to the PV input terminals is less than 185 VDC.  CAUTION: The PT controller can be damaged if the PV voltage is more than 200 VDC above the battery voltage or 240 VDC maximum, whichever is less.  Info: The digital display alternates this fault code (F03) with the DC voltage value determined on the PV input terminals.
  <p>FAULT LED ON</p>	<p>High Battery Fault - the PT controller turned off due to high voltage (≥ 68 VDC) detected on the battery input terminals (i.e., BAT+ to BAT-). This can be caused by incorrectly connecting the PV array to the battery terminals, or the battery bank is being charged by some external means and the voltage has exceeded 68 VDC.</p> <ul style="list-style-type: none">  Remedy: The fault will automatically clear and the controller will resume operation once the voltage to the battery input terminals is <66.4 volts DC. This fault can also be cleared manually by pressing the RESET pushbutton for one second once the voltage falls below 68 VDC.  CAUTION: The PT controller can be damaged if the voltage to the battery input terminals is above 68 VDC.  Info: The digital display alternates this fault code (F04) with the DC voltage value determined on the battery input terminals.
  <p>FAULT LED BLINKING</p>	<p>BTS Shorted Fault - the PT controller continues to run, but blinks the fault light to indicate that it has detected a problem with the BTS, and temperature compensated charging is no longer available.</p> <ul style="list-style-type: none">  Remedy: This can be caused by a shorted BTS cable or debris within the BTS RJ11 terminal. Either remove and replace the BTS (and cable), or check the BTS connector to ensure there are no shorted pins or debris inside. <i>Note: If caused by a faulty BTS, this fault will automatically clear once the BTS is removed.</i>
  <p>FAULT LED ON</p>	<p>FET Overtemp Fault - the PT controller turned off because the internal FET's (Field Effect Transistors) have exceeded their safe temperature operating range ($\geq 85^{\circ}\text{C}/185^{\circ}\text{F}$). <i>Note: If this fault happens often, ensure the controller is not in a hot area, has proper ventilation, and the cooling fans inside are working.</i></p> <ul style="list-style-type: none">  Remedy: This fault will automatically clear and the controller will resume operation when the FET temperature has cooled down below $83^{\circ}\text{C}/181^{\circ}\text{F}$. This fault can also be cleared manually by pressing the RESET pushbutton for one second when the FET temperature falls below $85^{\circ}\text{C}/185^{\circ}\text{F}$.  Info: The digital display alternates this fault code (F06) with the FET temperature.

  FAULT LED ON	<p>High Battery Temp Fault - the PT controller turned off because the temperature around the BTS has reached a temperature greater than 54°C/129°F.</p> <p> Remedy: Check the area where the BTS is located; if placed on a battery, ensure they are not overheated, or that the BTS hasn't been placed in a hot area or near a hot device. If neither of these are the issue, then remove the BTS from the BTS port. If the fault clears, replace the BTS. If the fault continues, then inspect the BTS port for cleanliness and/or have the controller serviced.</p> <p>This fault will automatically clear and the controller will resume operation when the BTS temperature has cooled down below 50°C/122°F. This fault can also be cleared manually by pressing the RESET pushbutton for one second when the BTS temperature falls below 54°C/129°F.</p> <p> Info: The digital display alternates this fault code (F07) with the BTS temperature.</p>
  FAULT LED ON	<p>Internal Overload Fault - the PT controller turned off to help protect itself because the current to an internal sensor has exceeded the controller's protection limits.</p> <p> Remedy: Press the RESET pushbutton for one second which should clear the fault and turn the controller on. If the fault cannot be cleared, their may be damaged/faulty components inside the controller and it will require repair.</p>
  FAULT LED ON	<p>Internal Phase Fault - the PT controller turned off to help protect itself because one or more of the internal phases is faulty, or the phase signals are not in sync with each other.</p> <p> Remedy: Press the RESET pushbutton for one second which should clear the fault and turn the controller on. If the fault cannot be cleared, their may be damaged/faulty components inside the controller and it will require repair.</p>
  FAULT LED BLINKING	<p>BTS Open Fault - the PT controller continues to run, but blinks the fault light to indicate that the BTS is no longer connected, and temperature compensated charging is no longer available. Normally when a BTS is connected, it communicates temperature information to the controller. This fault occurs when the controller is no longer receiving this information. This can occur if the BTS falls out or is disconnected or damaged.</p> <p> Remedy: The fault will automatically clear once a good BTS is reconnected. If the BTS is determined to be faulty, this fault can be cleared manually by removing the faulty BTS and pressing the RESET pushbutton for one second.</p>
  FAULT LED ON	<p>Internal Power Fault - the PT controller turned off to help protect itself because the internal power control circuitry reached it protection limits.</p> <p> Remedy: Press the RESET pushbutton for one second which should clear the fault and turn the controller on. If the fault cannot be cleared, their may be damaged/faulty components inside the controller and it will require repair.</p>

 	<p>GFDI Fault - the GFDI fuse in the PT controller has opened due to a ground-fault condition. Note: If the GFDI detection is not required, set DIP switch 2 UP.</p> <p> Remedy: Correct the ground-fault condition and replace the fuse (see Section 5.4). Once this is done, press the RESET pushbutton for one second to clear the fault and turn the controller on. Note: If the GFDI detection is not required, set DIP switch 2 UP.</p> <p> WARNING: Normally grounded conductors may be ungrounded and energized when a GFDI fault is indicated.</p>
 	<p>AFP Fault - Either a series arc has been detected in the PV system, or the arc-fault test button was pressed showing a successful self test has been performed.</p> <p> Remedy - If the arc-fault test switch was not pressed, then inspect the PV system for the cause of a series arc-fault. Some causes are loose or faulty/corroded wire connections or terminations, damaged wire strands, or damaged or corroded connection points inside components in the PV system (i.e., PV modules).</p> <p>Once the cause for the arc-fault has been determined and corrected, press the RESET pushbutton for one second to clear the fault and turn the controller on.</p>
 	<p>Internal NTC Fault - the PT controller turned off because the internal NTC (Negative Temperature Coefficient) temperature sensor suddenly caused a very large but unexpected temperature change.</p> <p> Remedy: Press and hold the RESET pushbutton until the display goes thru a power-up test routine (about 10 seconds). Once the fault has cleared, verify the controller comes on. If the fault cannot be cleared, there may be damaged/faulty components inside the controller and it will require repair.</p>
 	<p>Internal Hardware Fault - the PT controller turned off to help protect itself because the redundant hardware protection circuit that monitors the internal temperature has exceeded a safe operating limit.</p> <p> Remedy: Press and hold the RESET pushbutton until the display goes thru a power-up test routine (about 10 seconds). Once the fault has cleared, verify the controller comes on. If the fault cannot be cleared, there may be damaged/faulty components inside the controller and it will require repair.</p>
 	<p>Inductor Overtemp Fault - the PT controller turned off because the internal inductor has exceeded its safe temperature operating range ($\geq 132^{\circ}\text{C}/\geq 270^{\circ}\text{F}$).</p> <p> Remedy: If this fault happens often, ensure the controller is not in a hot area, has proper ventilation, and the cooling fans inside are working.</p> <p><i>Note: This fault will automatically clear and the unit will resume operation when the inductor temperature has cooled down below $127^{\circ}\text{C}/261^{\circ}\text{F}$.</i></p> <p> Info: The digital display alternates this fault code (F16) with the inductor temperature.</p>
	<p></p> <p>Communication Faults- The PT controller will not run because DIP switch 10 was inadvertently/incorrectly set UP.</p> <p> Remedy: These faults will automatically clear and the controller will begin operation once DIP switch 10 is set DOWN.</p>

5.4 Removing/Replacing the GFDI Fuse



WARNING: Dangerous voltages can exist inside the controller. Disconnect all PV and battery circuits to the PT controller before removing or installing the GFDI fuse. The PT controller has internal capacitors that remain charged after disconnecting all sources of power. Wait at least 2 minutes for these capacitors to discharge before servicing the unit.



WARNING: Performing service or maintenance on the controller can be life-threatening, if done improperly. Service on the controller (including replacing fuses) must only be performed by authorized personnel, these are qualified electricians and technicians who are familiar with PV system wiring and safety practices.



CAUTION: For continued protection against risk of fire, replace only with the same type and rating of fuse.

The fuse used in the GFDI circuit opens when severe leakage occurs between a current-carrying conductor in the PV system and an equipment grounding conductor or grounded surface/device. Before replacing the fuse, it is important that the ground fault is located and corrected.

To remove and replace the GFDI fuse:

1. Remove the access cover (see Section 2.3.1).
2. Locate the GFDI fuse holder (see Figure 5-1).
3. Use an insulated standard flat-blade screwdriver to remove and replace the GFDI fuse.



Info: The fuseholder is spring-loaded, so it will need to be pushed in before turning. Push-in and turn the cap on the fuseholder Counter Clock-Wise (CCW) to open/remove the cap and Clock-Wise (CW) to close/replace the cap (see Figure 5-1).



Info: The GFDI fuse is a 0.5 amp/300-volt DC rated fuse in a 5x20mm case made by Schurter Inc. It can be purchased from Digi-Key (www.digikey.com), the Digi-Key Part Number is 0001.2501-ND.

4. After the fuse has been replaced, reattach the access cover.

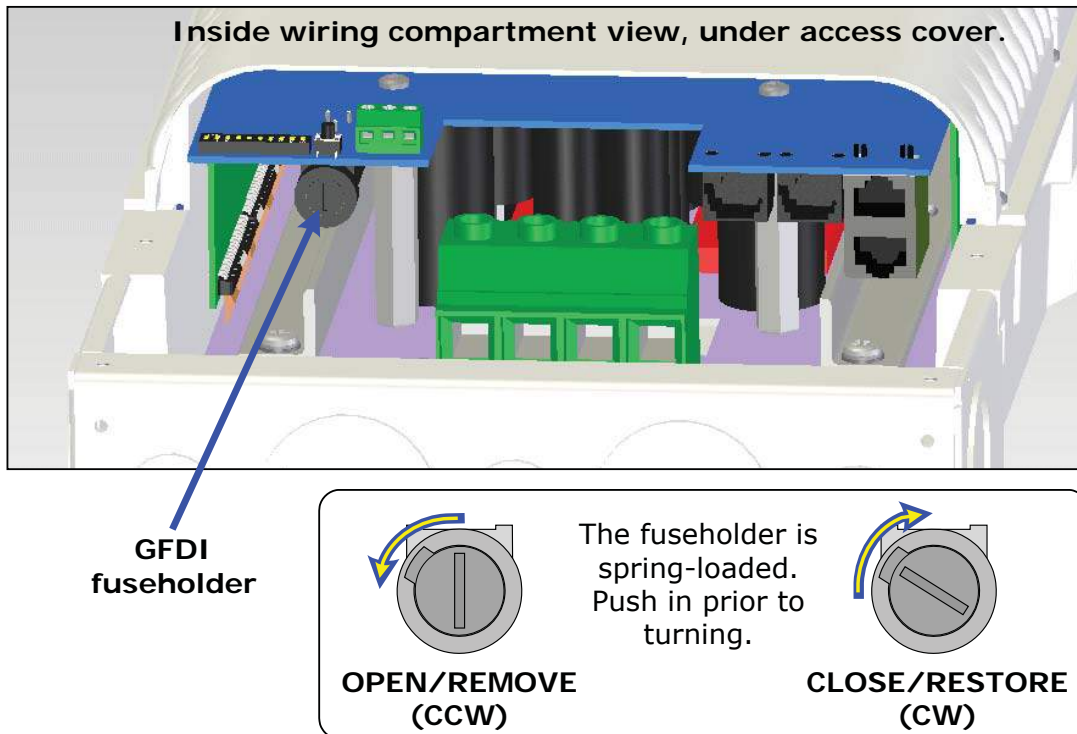

Figure 5-1, GFDI Fuse Location (Access Cover Removed)

5.5 Removing and Replacing the Electronics Section

The PT controller is designed as a two-piece unit, with a repairable upper electronics section physically connected to a lower non-serviceable wiring/conduit box—making it easier to service. This allows any wiring/conduit connected to the PT controller to remain in place, while the electronics section is easily removed and replaced if service is required.

To replace the electronics section on the PT controller (refer to Figure 5-2):

1. If it has not already been removed, remove the access cover from the PT controller.
2. Mark, then remove any connection between the electronics section and the wiring/conduit box.



Info: Before removing any connection and wires, mark them to correspond with their component connection and terminals to prevent incorrect wiring when reconnecting.

3. Remove the two lower screws (#8/32 x 3/8" Phillips) that hold the electronics section to the wiring/conduit box.
4. While using one hand against the front of the electronics section to hold it in place, use the other hand to remove the two upper screws (#8 x 3/4" Phillips) that are holding the electronics section to the mounting bracket.
5. Now that all the screws holding the electronics section are removed, it can be removed by pulling it forward (away from the wall)—sliding it out of the wiring/conduit box.
6. To replace the electronics section, reverse the previous steps—ensuring the upper and lower screws are correctly secured and all connections are wired correctly, and properly torqued according to the values shown in Table 2-6 and 2-7 in Section 2.7.3.
7. Perform the power-up test as described in Section 2.12.2.

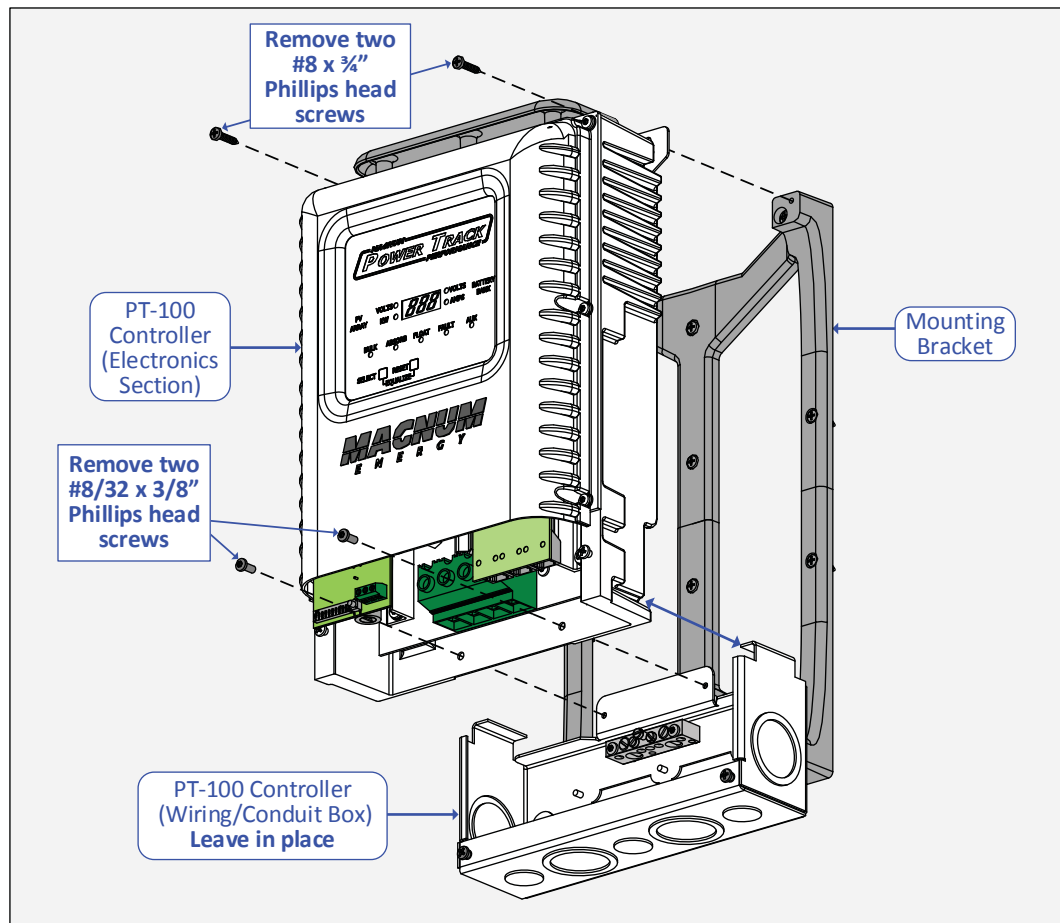

Figure 5-2, Electronics Section Removal

5.6 Resetting the PT-100 Charge Controller

Certain conditions—such to clear an internal fault—require that the PT-100 be reset. Most times a software reset (also known as a soft reset) is sufficient, otherwise a power reset is (also known as a hard reset) is required.

5.6.1 Performing a Software Reset (AKA Soft reset)

To perform a software reset (also known as a soft reset):

1. Remove all PV power to the PT controller—normally done by opening the PV input breaker.
2. Ensure the PT controller is connected to battery power by verifying that any LED indicator on the PT controller’s front display is on.
3. Press and hold the RESET pushbutton (see Figure 5-3) for ten (10) seconds until the PT controller begins performing the diagnostic power-up test routine (see Section 2.12.2).
4. Once the power-up test is completed, if the PT controller appears to be operating normally, apply PV power (close the PV input breaker).
5. If the controller continues to operate normally after applying PV power, resume operation.

If any of the steps fail or the charge controller continues to show an internal fault, perform a power reset using the procedure below.

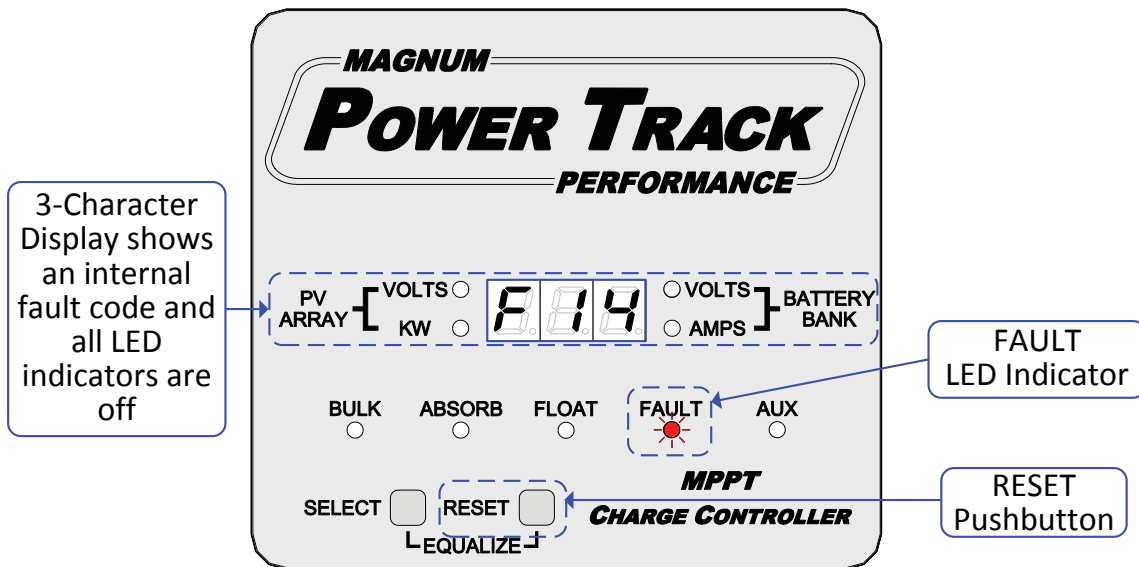

Figure 5-3, PT Controller Reset

5.6.2 Performing a Power Reset (AKA Hard reset)

To perform a power reset (also known as a hard reset):

1. Remove all power (PV and battery) to the charge controller, this is normally done by opening the PV input and battery input disconnects.
2. Remove any cable that is plugged into any accessory port (i.e., BTS, REMOTE).
3. Verify the charge controller is disconnected from all power by pressing both pushbuttons, and ensure all LEDs and the display are off.
4. After the charge controller has been disconnected from all power for 5 minutes, connect only battery power to the charge controller and verify the controller performs the diagnostic power-up test routine (see Section 2.12.2).
5. Once the power-up test is completed, if the PT controller appears to be operating normally, then apply PV power (close the PV input breaker).
6. If the controller continues to operate normally after applying PV power, resume operation.

If any of the steps fail or the charge controller continues to show a fault, the charge controller will require repair at an Authorized Service Center (ASC).

Appendix A – Specifications and Optional Equipment

A-1 PT-100 Charge Controller Specifications

Electrical Specifications	
Maximum PV Input Voltage (any condition)	200VDC + battery voltage or 240VDC –whichever is lower
PV Operating Voltage	(VBat + 8V) to 187 VDC
Maximum Input Current	100 ADC
Nominal Battery Voltage Options	12, 24, or 48 VDC
Battery Charger Output Voltage Range	1 to 66 VDC
Continuous Charger Output Current	100 ADC (from -20°C to +40°C) with proportional power reduction up to +60°C ambient
Maximum Output Power	6600 watts
Peak (and Full Power) Efficiency	>99% (98% typical)
Tare Loss/Night-time Power Consumption	<4 watts (fan off, display/LEDs off)
Charger Regulation Method	Automatic 3-stage (Bulk, Absorption, Float) charge with manual Equalization
General Features and Capabilities	
Battery Temperature Compensation	With BTS connected (battery temp -20 to 55°C)
Internal Cooling	Uses dual ball-bearing fans for long life
Overcurrent Protection	With two overlapping circuits
Over-Temperature Protection	On transformer and MOSFETS
Certifications	ETL listed to UL/cUL 1741, Certified to CSA C22.2 No. 107.1-01, CE certified
Warranty	5 years parts and labor
Environmental Specifications	
Operating Temperature	-20°C to +60°C (-4°F to 140°F)
Non-operating Temperature	-40°C to +70°C (-40°F to 158°F)
Operating Humidity	0 to 95% RH non-condensing
Physical Specifications	
Enclosure Type	Indoor, ventilated, with removable powder-coated conduit box
Unit Dimensions (width x height x depth)	8.5" x 15.5" x 4.0" (21.6 cm x 10.2 cm x 39.4 cm)
Shipping Dimensions (w x h x d)	11.5" x 19.5" x 8.125" (29.2 cm x 49.5 cm x 20.6 cm)
Mounting	Mounted vertically or installed on MP or MMP Enclosure
Weight	Unit: 12.5 lb (5.7 kg) / Shipping: 15 lb (6.8 kg)
Max Operating Altitude	15,000 ft (4570 m)
<i>Unless otherwise noted, specifications @ 77°F (25°C) – subject to change without notice.</i>	

A-2 Performance Graphs

A-2.1 Ambient Temperature versus Continuous Current

As the temperature of the power devices inside the PT-100 increases, the maximum allowable charger current is reduced. The following curve shows the effect of charger current with the temperature above 40°C.

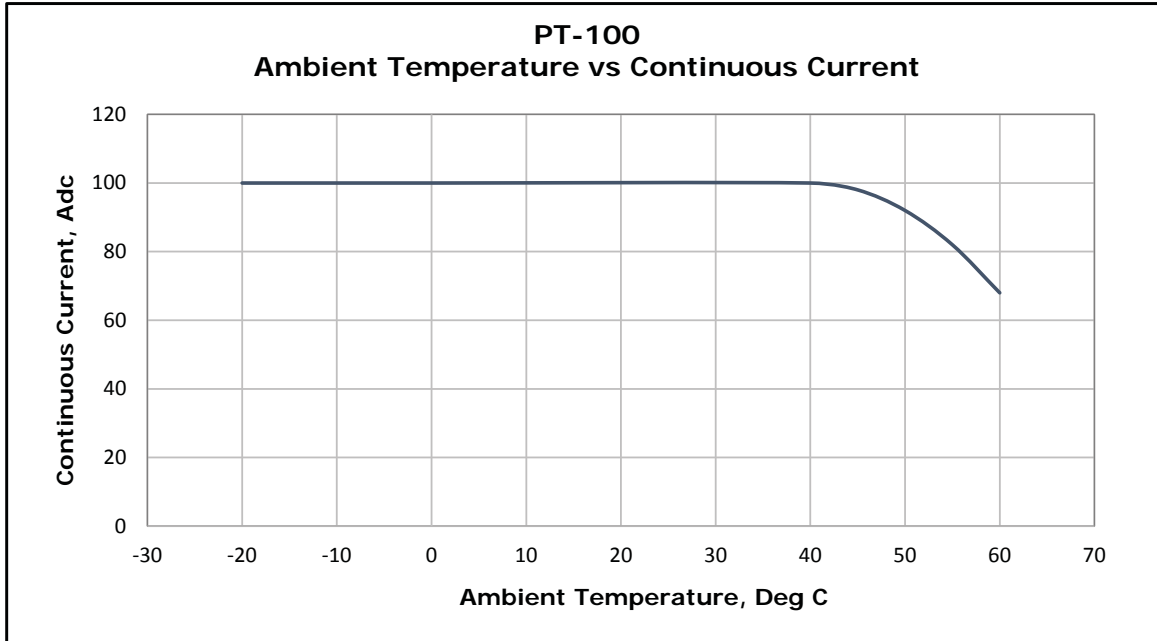

Figure A-1, Ambient Temperature vs Continuous Current Curve

A-2.2 Output current versus Battery Voltage

The following curve shows the PT-100’s output current at different battery voltage levels. The output current of the PT-100 is consistent throughout it’s battery voltage range.

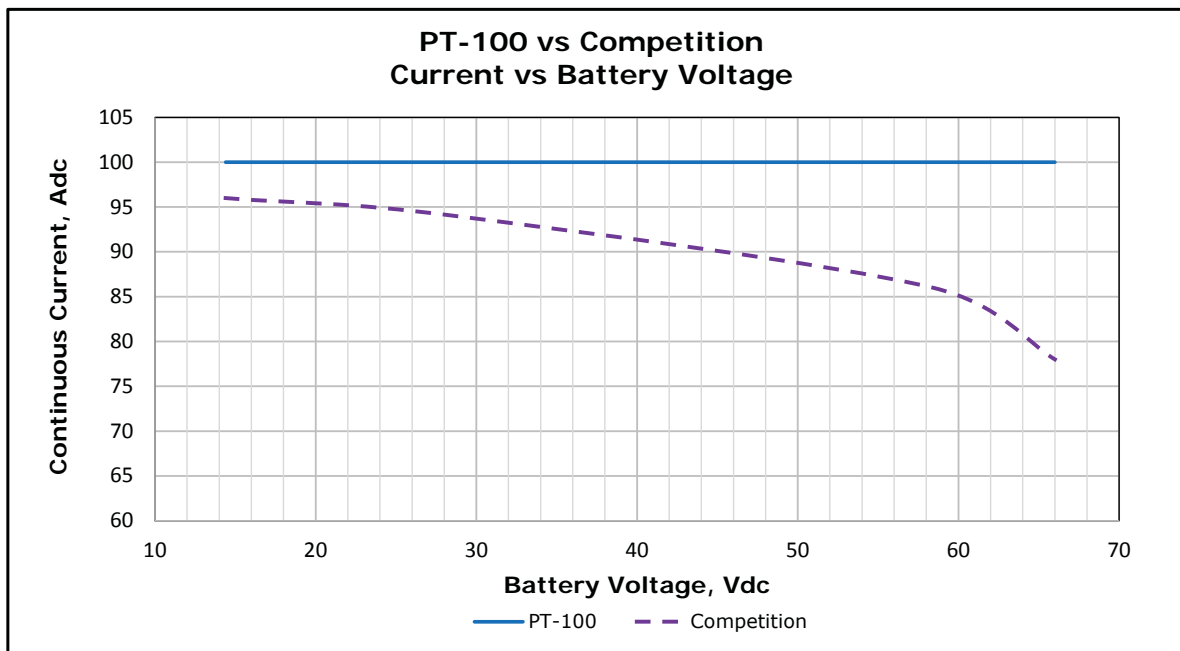

Figure A-2, Output Current vs Battery Voltage Curve

A-2.3 Maximum Power versus MPP Voltage

The following curve shows the PT-100's output power at different PV input MMP voltage levels. The output power of the PT-100 is consistent throughout it's PV input MMP voltage range.

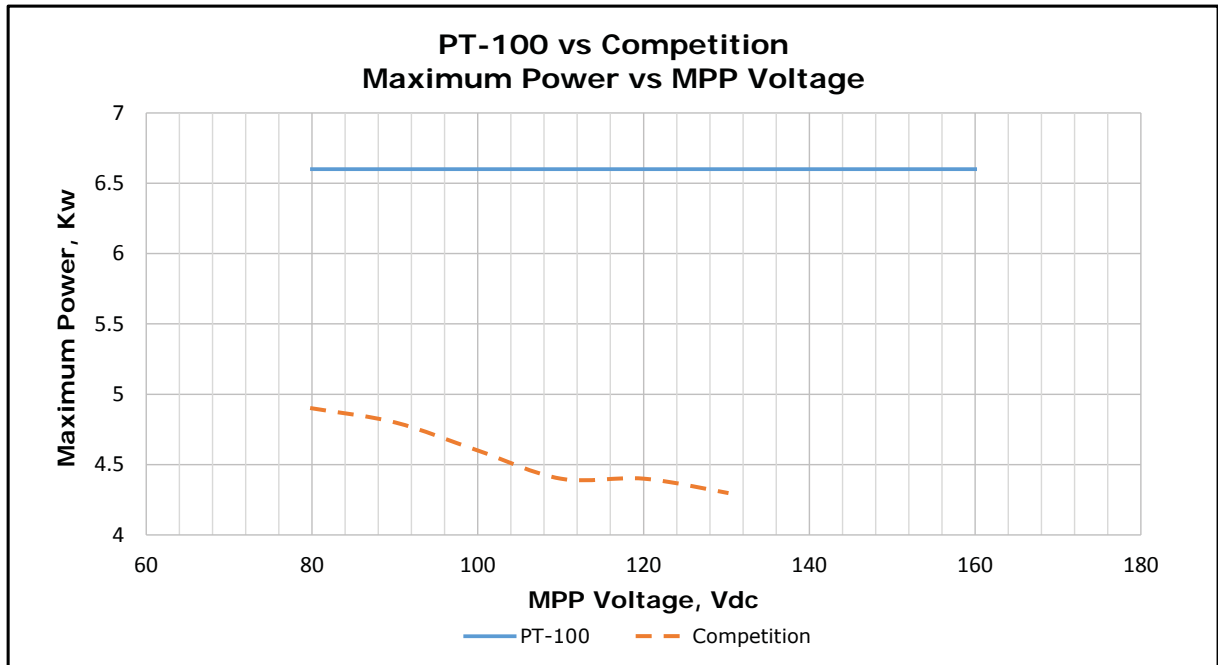

Figure A-3, Maximum Power vs MPP Voltage Curve

A-3 Optional Equipment and Accessories

The following components are available for use with the PT-100 Series charge controller. Some of these items are required. Depending upon the intended use of the charge controller.

Standard Remote Control

The ME-RC remote control panel uses an LCD screen and at-a-glance LED's to provide operating information; also provides monitoring, troubleshooting, and feature configuration.

Advanced Remote Control

The ME-ARC remote control panel uses an LCD screen and at-a-glance LED's for complete charge controller status and operating information. This LCD remote control also provides advanced monitoring/troubleshooting and includes a FAVS button to quickly access your favorite features.

Battery Monitor Kit

The ME-BMK (and ME-BMK-NS) Battery Monitor Kit is a single battery bank amp-hour meter that monitors the condition of the battery, provides information to let you know how much energy is available, and lets you plan your electrical usage to ensure the battery is not being over-discharged.

Note: The DC shunt is included with MMP and MP Series enclosures. Order the ME-BMK-NS version when installed with the MMP or MP enclosures.

Magnum Panels

The MP and MMP Series panels which have been specifically designed to conveniently connect a Magnum inverter and PT-100 charge controller together. These panels allow the PT-100's required PV and battery DC disconnects and all wire connection points to be connected together, accessible from the front, and marked in an easy to install pre-wired enclosure.

ME-CB and MPX-CB Conduit Boxes

The ME-CB and MPX-CB Conduit Boxes are provided for installations where the electrical code requires the AC and/or DC wiring to your charge controller to be enclosed and protected by conduit.

Appendix B – Charge Controller Terminology

The following is a glossary of terms with which you may not be familiar. They appear in the various descriptions of charge controller and battery charger operation.

Absorption Stage – In this second stage of three stage charging, the batteries are held at a constant voltage (the absorb voltage setting) and the battery is charged to its maximum capacity.

Ampacity – The ampacity of a wire is its current carrying capacity with reference to the cross-sectional area of the conductors, the temperature rating of the insulation and the ambient temperature.

Bulk Charge Stage – The first stage in three-stage charging. In this stage, a constant current is fed to the batteries and as they accept the current the battery voltage will rise.

CEC (Canadian Electrical Code) – The guidelines and acceptable practices for electrical installations in Canada.

Current (Amps) – The amount of electricity flowing through a conductor.

DC (Direct Current) – Electrical current that does not vary with time (i.e., battery voltage).

Deep Cycle – A deep cycle occurs when a battery is discharged to less than 20% of its capacity (80% depth-of-discharge).

Deep Cycle Battery – A battery designed to be routinely discharged to 20% of its maximum capacity without damage. This type of battery is recommended for use with a charge controller system.

Derating – As a charge controller (or charger) is used above its normal temperature, it's capacity to power loads (or charge) continuously is decreased.

Digital Volt Meter (DVM):

True RMS – A voltmeter that incorporates a RMS converter to read true RMS for any waveform shape.

Averaging Type – A voltmeter that requires a sine wave waveform shape to provide an accurate reading.

Efficiency – Usually given as a percentage, efficiency is the ratio of the output to the input. The efficiency changes with power output levels of any charge controller.

Electrolyte – Typically a mixture of water and sulfuric acid that is used in lead-acid batteries; it is commonly referred to as battery acid.

Equalization – Controlled "overcharging" of the battery causing it to bubble and mix. This helps reduce stratification.

Float Stage – During the third stage of three-stage charging, the voltage and current are reduced to a level that will trickle charge or maintenance charge the battery. This assures the battery remains fully charged even while sitting.

Fuse or Disconnect – When current exceeds a preset limit, the fuse or disconnect will fail before the wiring or equipment it is protecting. Disconnects are also called circuit breakers. These are usually reset, and can act as a switch to turn off power to equipment for servicing.

LED (Light Emitting Diode) – A light made up of semi-conducting material.

Load(s) – An electrical item that draws power (e.g., lights, radio, refrigerator, etc.,) to work.

NEC (National Electric Code) – The guidelines and acceptable practices for electrical installations in the USA.

Off Grid – Not connected to public power in any way.

Pass Through Current – The amount of current the charge controller can safely pass directly from the AC input to the AC output.

Photovoltaic (PV) – Solar powered.

Resistance (Ohms) – Slows the electrical flow of direct current (DC).

RMS (Root Mean Square) – A measure of AC voltage that provides the equivalent heating value across a resistor as would a DC source of the same voltage.

Stratification – Over time, a battery's electrolyte (liquid) tends to separate. The electrolyte at the top of the battery becomes watery, while at the bottom it becomes more acidic. This effect is corrosive to the plates.

Sulfating – As a battery discharges, its plates become covered with lead sulfate. During recharging, the lead sulfate leaves the plates and recombines with the electrolyte. If the lead sulfate remains on the plates for an extended period of time (over two months), it hardens, and recharging will not remove it. This reduces the effective plate area and the battery's capacity.

Temperature Compensation – Peak available battery voltage is temperature dependent. As ambient temperatures fall, the proper voltage for each charge stage needs to be increased. A Battery Temperature Sensor (BTS) automatically re-scales charge voltage settings to compensate for ambient temperatures.

Voltage – The pressure that causes electrical flow in a circuit.

Watts – Measure of power output or utilization. $\text{Watts} = \text{Volts} \times \text{Amps}$.

Appendix C – PV Conductor and OCPD Sizing Worksheet

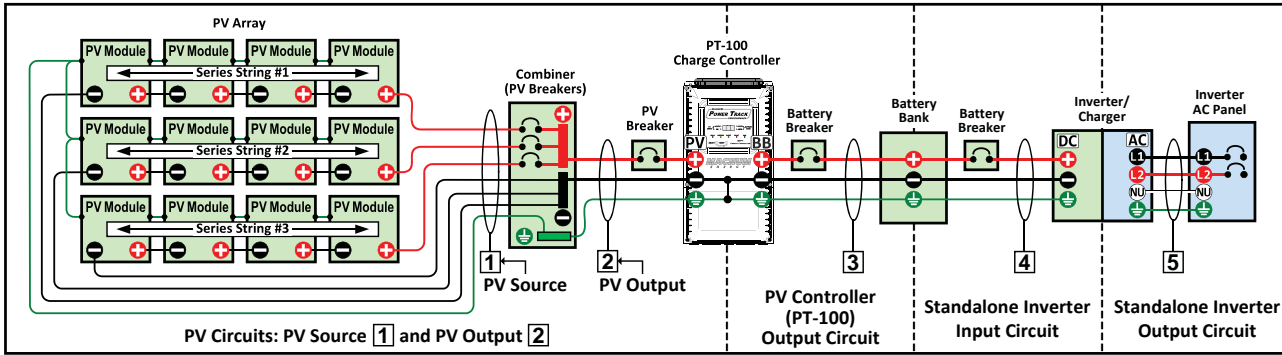

Sizing Conductors and Overcurrent Protection Device Ratings in the PV System

To calculate the required conductor and overcurrent protection device sizes, follow these steps:

PV Circuits (PV Source and PV Output):

Step 1) Calculate the maximum current for the PV circuits (I_{MAX}):

Max current for PV source ($PV_{SOURCE}-I_{MAX}$) = Module I_{SC} x 1.25	$PV_{SOURCE}-I_{MAX}$ =
Max current for PV output ($PV_{OUTPUT}-I_{MAX}$) = $PV_{SOURCE}-I_{MAX}$ x # of strings	$PV_{OUTPUT}-I_{MAX}$ =

Step 2) Determine the PV circuit conductor size for continuous circuit currents (I_{CONT}):

a) Calculate the continuous current for the PV circuits (I_{CONT}):

Continuous current for PV source ($PV_{SOURCE}-I_{CONT}$) = $PV_{SOURCE}-I_{MAX}$ x 1.25	$PV_{SOURCE}-I_{CONT}$ =
Continuous current for PV output ($PV_{OUTPUT}-I_{CONT}$) = $PV_{OUTPUT}-I_{MAX}$ x 1.25	$PV_{OUTPUT}-I_{CONT}$ =

b) Find the PV circuit's conductor sized for continuous current:

Look at Table 310.15 (B)(16) and select the insulation temperature rating column that corresponds to the lowest temperature rating of any terminal the conductor is terminated on—regardless of the insulation of the selected conductor. Select the smallest conductor that exceeds the continuous current (I_{CONT}) calculation from Step 2a.

PV circuit continuous current:	$PV_{SOURCE}-I_{CONT}$ =	$PV_{OUTPUT}-I_{CONT}$ =
Lowest terminal temperature:		
Conductor sized to continuous currents:	(AWG @Temp)	(AWG @Temp)

Step 3) Determine the conductor size for maximum circuit currents derated after adjustment factors (I_{DERATE}):

a) Calculate the ampacity of the conductors in the PV circuits derated by the following "conditions of use" factors:

1. Conduit Fill Factor (Fill Factor) – When more than three current carrying conductors are in conduit (or bundled together) in continuous lengths >24 inches, then divide by the *Conduit Fill Factor* from Table 310.15(B)(3)(a).
2. Temperature Correction Factor (Temp Factor) – If the average ambient temperature (Avg. Temp)—in addition to the *Rooftop Temperature Adder**—is greater than 30°C, then these two temperatures become the effective ambient temperature (Eff. Temp) value. Use this Eff. Temp to determine the appropriate *Correction Factor*** from Table 310.15(B)(2)(a).

* *Rooftop Temperature Adder (Rooftop Add.)* – Conductors/raceways exposed to sunlight on a roof require the ambient temperature to be increased—based on the distance from the roof—using a temperature adder from Table 310.15(B)(3)(c).

** *Correction Factor* – to determine the correct temperature factor, the Conductor's Temperature Rating is required.

Avg. Temp		Max PV source circuit current with conditions of use			$PV_{SOURCE}-I_{DERATE}$
Rooftop Add.	+	$(PV_{SOURCE}-I_{DERATE}) = (PV_{SOURCE}-I_{MAX} \div \text{Fill Factor} \div \text{Temp Factor})$			
Eff. Temp	=	$PV_{SOURCE}-I_{MAX}$ =	Fill Factor =	Temp Factor =	
Avg. Temp		Max PV output circuit current with conditions of use			$PV_{OUTPUT}-I_{DERATE}$
Rooftop Add.	+	$(PV_{OUTPUT}-I_{DERATE}) = (PV_{OUTPUT}-I_{MAX} \div \text{Fill Factor} \div \text{Temp Factor})$			
Eff. Temp	=	$PV_{OUTPUT}-I_{MAX}$ =	Fill Factor =	Temp Factor =	

b) Find the PV circuit's conductor size after derating factors have been applied:

Look at Table 310.15(B)(16) and select the insulation temperature rating column that corresponds to the lowest temperature rating of any terminal the conductor is terminated on, regardless of the insulation of the selected conductor. Select the smallest conductor that exceeds the derated current (I_{DERATE}) calculation from Step 3a.

PV circuit derated current:	PV _{SOURCE} - I_{DERATE} =	PV _{OUTPUT} - I_{DERATE} =
Temperature rating of selected conductor:	(AWG @Temp)	(AWG @Temp)
Lowest terminal temperature:		
Conductor sized after derating factors:	(AWG @Temp)	(AWG @Temp)

Step 4) Determine the minimum required conductor size:

Compare the conductor sized to the continuous current (Step 2b) against the conductor sized after derating factors (Step 3b); the largest conductor size between the two is the minimum required conductor.

Conductor Sized to the Continuous Current (AWG @Temp):	Conductor Sized after Derating Factors (AWG @Temp):	Minimum Required Conductor Size (AWG @Temp):
PV _{SOURCE} - I_{CONT} =	PV _{SOURCE} - I_{DERATE} =	PV Source =
PV _{OUTPUT} - I_{CONT} =	PV _{OUTPUT} - I_{DERATE} =	PV Output =

Step 5) Size the Overcurrent Protection Device (OCPD) to protect the selected conductor:

Ensure the size of the OCPD is equal to or greater than the Continuous Current (Step 2) and equal to or less than the ampacity of the Minimum Required Conductor (Step 4) using a commonly available size (NEC Article 240.6).

Continuous Current ($I_{MAX} \times 125\%$):	Minimum Required Conductor:		Size of the Overcurrent Protection Device (OCPD)* ($I_{MAX} \times 125\%$)
	Size (AWG @ Temp)	Ampacity	
**PV _{SOURCE} - I_{CONT} =			
PV _{OUTPUT} - I_{CONT} =			

**If the OCPD is rated for 100% operation, then it can be sized to the lower I_{MAX} current (Step 1).*

***The OCPD for each PV source conductor cannot exceed the "Series fuse" listed on the module label.*

Note: Consult manufacturer for OCPD rating if exposed to temperatures greater than 40°C.

Appendix D – Warranty and Service Information

D-1 Limited Warranty

Sensata Technologies warrants the PT-100 to be free from defects in material and workmanship that may result in product failure during normal usage, according to the following terms and conditions:

1. The limited warranty for the product extends for 60 months beginning from the product's original date of purchase.
2. The limited warranty extends to the original purchaser of the product and is not assignable or transferable to any subsequent purchaser.
3. During the limited warranty period, Sensata Technologies will repair or replace at Sensata's option any defective parts—or any parts that will not properly operate for their intended use—with factory new or rebuilt replacement items if such repair/replacement is needed because of product malfunction or failure during normal usage. The limited warranty does not cover structural or non-operative parts, or any defects in appearance be they cosmetic or decorative. Sensata Technologies limit of liability under the limited warranty shall be the actual cash value of the product at the time the original purchaser returns the product for repair, determined by the price paid by the original purchaser. Sensata shall not be liable for any other losses or damages.
4. Upon request from Sensata Technologies, the original purchaser must prove the product's original date of purchase by presenting a dated bill of sale or itemized receipt.
5. The original purchaser shall return the product prepaid to Sensata Technologies in Everett, WA, or to one of Sensata's Authorized Service Centers (ASC). After the completion of service under this limited warranty, the product will be returned prepaid to the original purchaser via non-expedited surface freight within the contiguous United States and Canada; this excludes Alaska and Hawaii.
6. If Sensata repairs or replaces a product, its warranty continues for the remaining portion of the original warranty period or 90 days from the date of the return shipment to the original purchaser, whichever is greater. All replaced products and parts removed from the repaired products become the property of Sensata.
7. This limited warranty is voided if:
 - the product has been modified without authorization
 - the serial number has been altered or removed
 - the product has been damaged from abuse, neglect, accident, high voltage or corrosion
 - the product was not installed and operated according to the owner's manual

D-2 How to Receive Repair Service

If your product requires warranty service or repair, contact either:

- An authorized service center listed on the <http://magnum-dimensions.com> website; or
- Sensata Technologies (Magnum-Dimensions Products) at:
Phone: 425-353-8833, Fax: 425-353-8390, Email: MagnumWarranty@Sensata.com

If returning the product directly to Sensata Technologies for repair, you must:

1. Return the unit in the original, or equivalent, shipping container. *Note: When shipping your product, please ensure it is properly packaged. **Damage due to inadequate packaging is not covered under warranty.** We recommend sending the product by traceable or insured service.*
2. Receive a Return Materials Authorization (RMA) number from the factory prior to the return of the product to Sensata Technologies for repair.
3. Place the assigned RMA numbers clearly on the shipping container or on the packing slip.

**BEFORE RETURNING ANY UNIT TO SENSATA TECHNOLOGIES,
A RETURN MATERIAL AUTHORIZATION (RMA) NUMBER IS REQUIRED**



p. 1.866.258.0110
f. 1.866.437.5531
w. hespv.ca
e. sales@hespv.ca

MAGNUM DIMENSIONS

Magnum-Dimensions Products

Manufactured by:

Sensata Technologies
2211 West Casino Rd.
Everett, WA 98204
Phone: 425-353-8833
Fax: 425-353-8390

Web: www.magnum-dimensions.com/